

This exhibition rack does not need floor.

European standard technology,
scientific bypass structure



T1 9C(101)	Panels	1015 e: 15 mm x: 9 panels	45kg
Black Charcoal Silver White	Packaging	1180 x 2270 700	379 kg
	Displays quantity container	12 20 ft	27 40 ft

European standard technology,
scientific bypass structure



T1 11C(101)	Panels	Packaging	Displays quantity container
Black Charcoal Silver White	1015 e: 15 mm x: 11 panels	1240 x 2270 700 335 kg	12 20 ft 27 40 ft
T1 11C(121)	1205 e: 15 mm x: 11 panels	1380 x 2690 730 460 kg	6 20 ft 12 40 ft

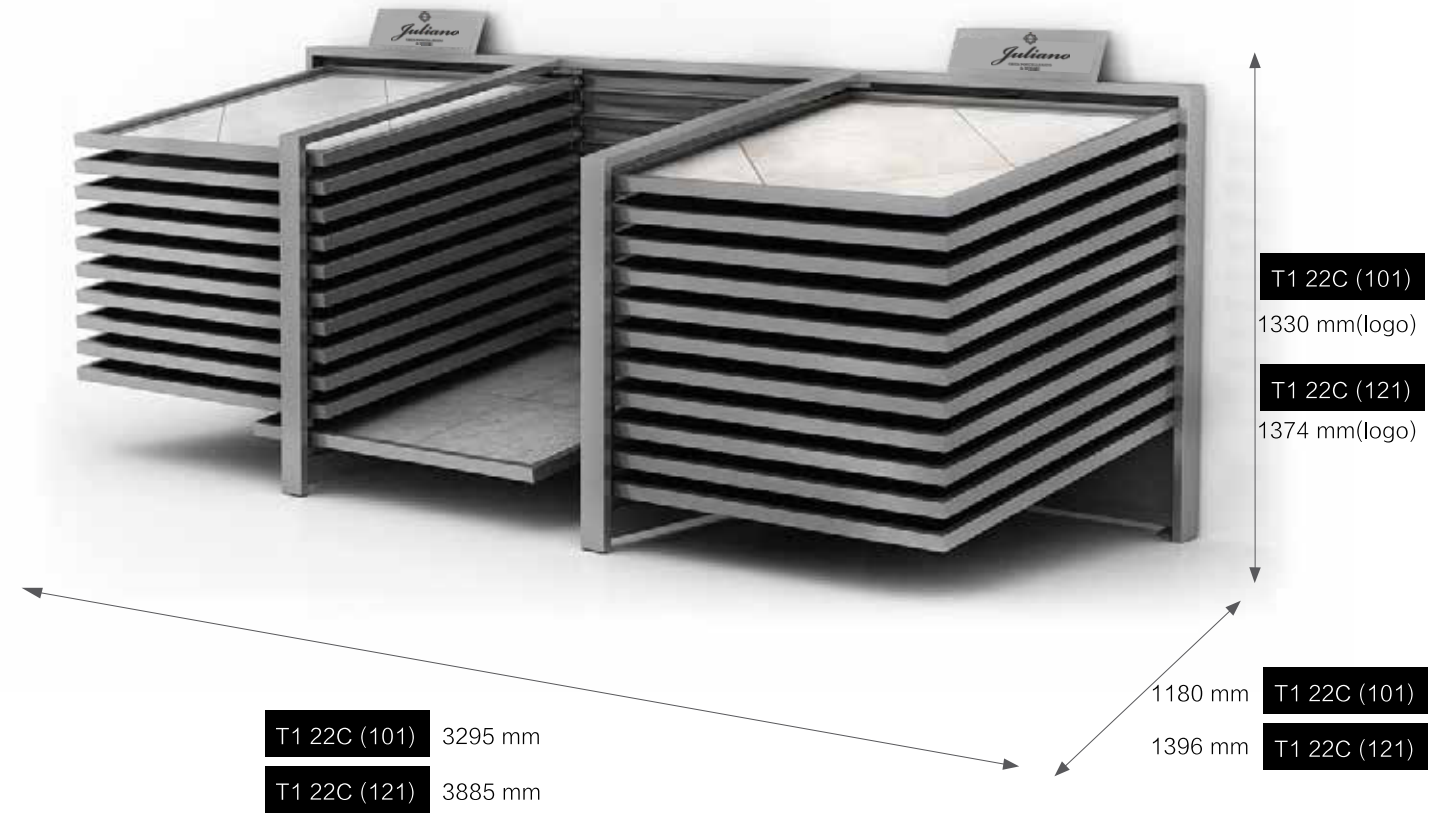
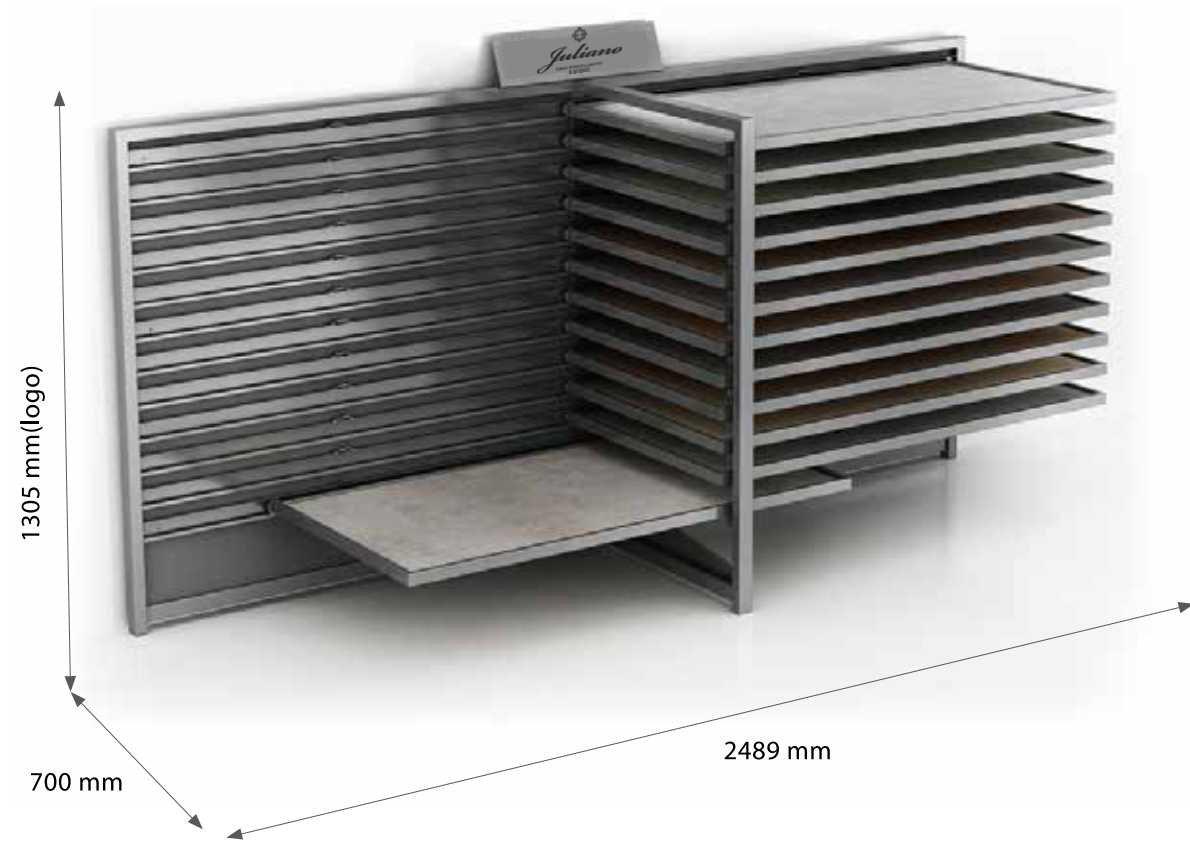

This exhibition rack does not need floor.

European standard technology,
scientific bypass structure



T1 12C(1200X600)	Panels	600/1200 e: 12 mm x: 12 panels	20kg
Black	Packaging	1330 450 2550	281 kg
Charcoal	Displays quantity container	10 20 ft	20 40 ft
Silver			
White			

European standard technology,
scientific bypass structure



Black	Panels	Packaging	Displays quantity container
Charcoal			
Silver			
White白色			
T1 22C(121)	x: 22 panels	1015 e: 15 mm 35 kg	1240 1150 2270 595 kg 7 20 ft 17 40 ft
	x: 22 panels	1205 e: 15 mm 45 kg	1380 1230 2690 730 kg 2 20 ft 4 40 ft

Ceramic display rack global customization

Original patent product

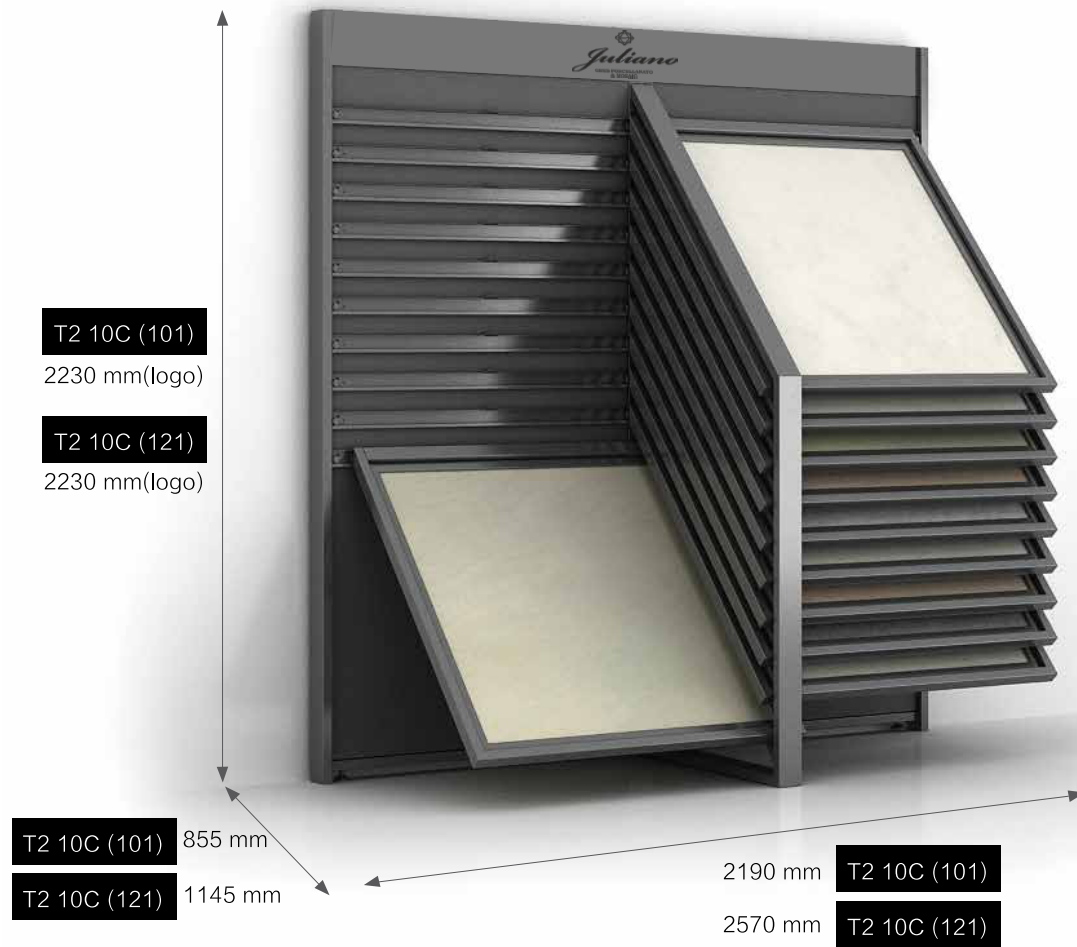

This exhibition rack does not need floor.

European standard technology,
scientific bypass structure



Color	Panels	Packaging	Displays quantity container
Black			
Charcoal			
Silver			
White			
T2 10C(121)	1015 x 1015 mm e: 15 mm x: 10 panels 35 kg	1180 x 2270 mm 770 mm height 387 kg	12(80) / 15(101) 20 ft / 40 ft
	1205 x 1205 mm e: 15 mm x: 10 panels 45 kg	1380 x 2690 mm 840 mm height 496 kg	4 / 8 20 ft / 40 ft

European standard technology,
scientific bypass structure



Color	Panels	Packaging	Displays quantity container
Black			
Charcoal			
Silver			
White			
T2 10C(800x800)	1200 x 600 mm e: 12 mm x: 12 panels 20 kg	1330 x 2280 mm 450 mm height 240 kg	19 / 39 20 ft / 40 ft
	800 x 800 mm e: 12 mm x: 10 panels 35 kg	980 x 2290 mm 875 mm height 350 kg	12 / 23 20 ft / 40 ft

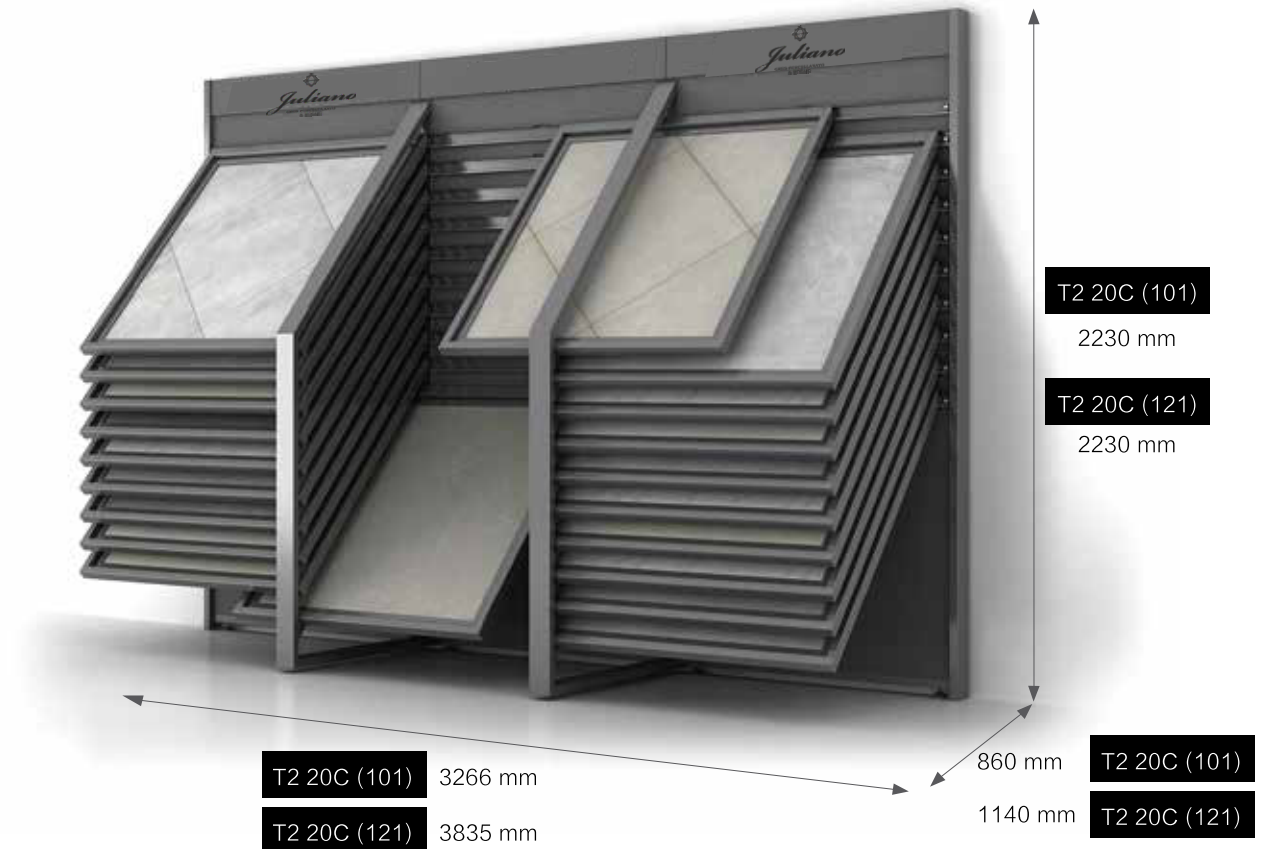

This exhibition rack does not need floor.

European standard technology,
scientific bypass structure



Color	Dimensions	Weight
T2 20C(800X800)	800 x 800 mm, e: 12 mm, x: 20 panels	35 kg
Black	980 x 2290 mm, 1175 mm height	450 kg
Charcoal		
Silver		
White	12 x 20 ft container	23 x 40 ft container

European standard technology,
scientific bypass structure



Color	Dimensions	Weight	Containers
Black			
Charcoal			
Silver			
White			
T2 20C(101)	1015 x 1015 mm, e: 15 mm, x: 20 panels	35 kg	4 x 20 ft, 9 x 40 ft
T2 20C(121)	1205 x 1205 mm, e: 15 mm, x: 20 panels	45 kg	2 x 20 ft, 4 x 40 ft

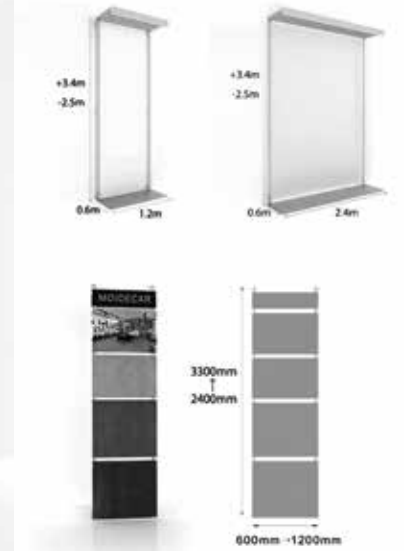
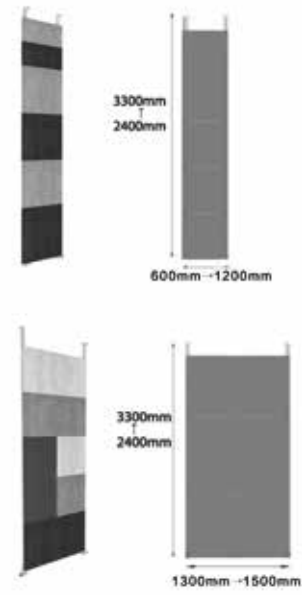

This exhibition rack does not need floor.

European standard technology,
scientific bypass structure



LEGOS DU(5P)	Panels	e: 15 mm	x: 5 panels	45kg
Black	Packaging	900	3000	200kg
Charcoal		400		
Silver	Displays quantity container	5	20 ft	12
White白色				40 ft

European standard technology,
scientific bypass structure



LEGOS IC(10P)	Panels	e: 15 mm	x: 5 panels	55kg
Black	Packaging	900	3000	300 kg
Charcoal		500		
Silver	Displays quantity container	6	20 ft	10
White				40 ft

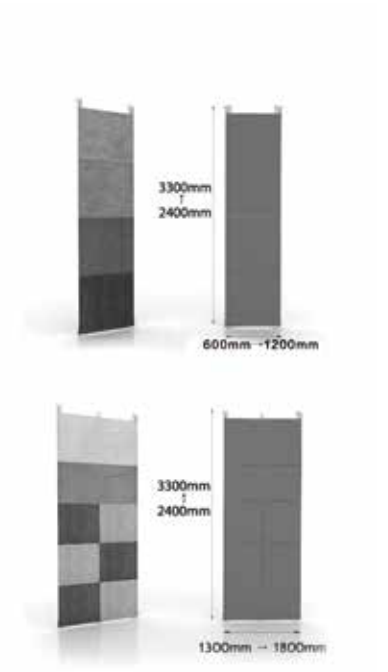

This exhibition rack does not need floor.

European standard technology, scientific bypass structure



LEGOS HV(10P)	Panels	e: 15 mm x: 5 panels	65kg
Black	Packaging	900 x 3000 x 600	400kg
Charcoal	Displays quantity container	1 20 ft	3 40 ft
Silver			
White			

Ceramic display rack global customization

Original patent product

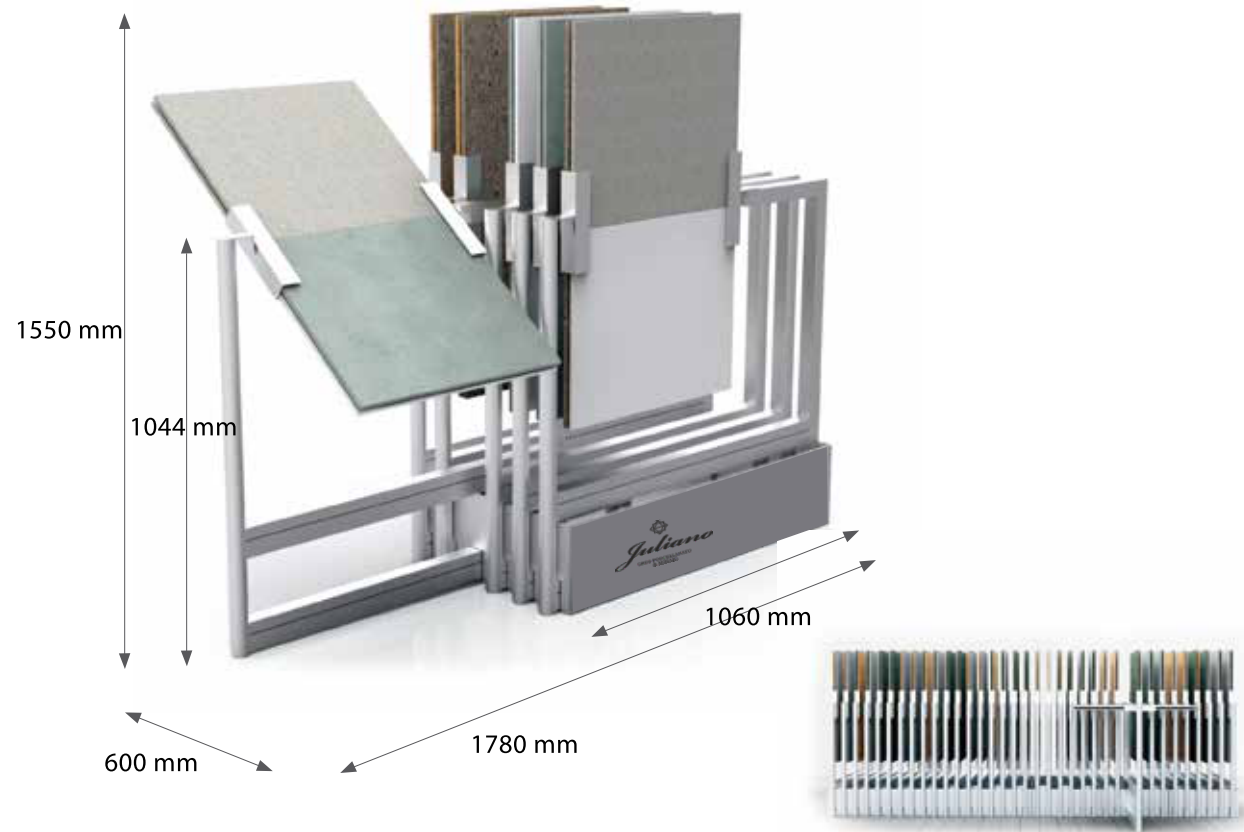

This exhibition rack does not need floor.

European standard technology,
scientific bypass structure



ROCK GYRATORY	Panels	600/1200 e: 12 mm 600	(24)600X600 (12)600X1200	35kg
Black	Packaging	1110 720	1140	120 kg
Charcoal	Displays quantity container	30 20 ft	60 40 ft	
Silver				
White				

European standard technology,
scientific bypass structure



ROTARY	Panels	600/1200 e: 12 mm 600	(10)600X600 (20)600X1200	35kg
Black	Packaging	1110 370	1140	379 kg
Charcoal	Displays quantity container	30 20 ft	60 40 ft	
Silver				
White				

ROCK 8P



(4, 6, 8, 10, 12, 14) This exhibition rack does not need floor.

European standard technology,
scientific bypass structure



ROCK 8P	Panels	600 e: 12 mm 600/1200 x: 8panels	35kg
Black	Packaging	700 380 1080	77.3 kg
Charcoal	Displays quantity container	80 20 ft	170 40 ft
Silver			
White			

European standard technology,
scientific bypass structure



	Panels	900 e: 12 mm 1800 x: 8panels	35kg
Black	Packaging	700 380 1080	150 kg
Charcoal	Displays quantity container	80 20 ft	170 40 ft
Silver			
White			

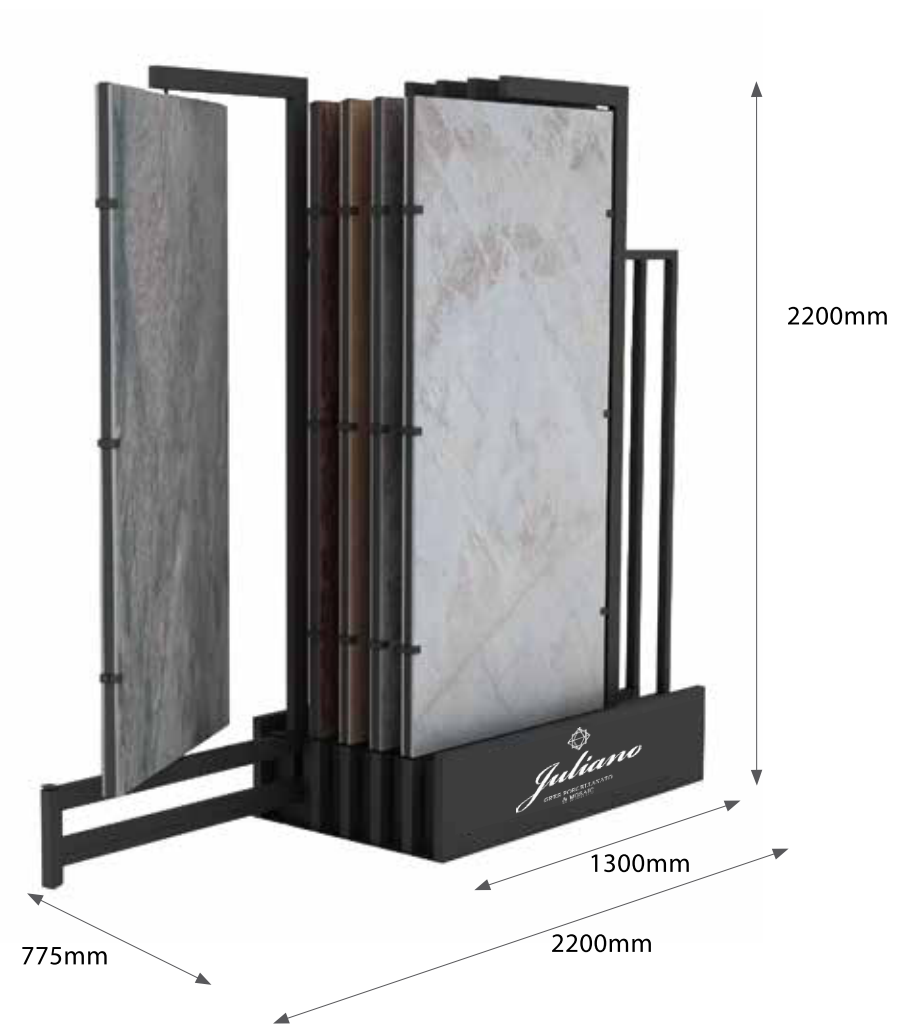

European standard technology,
scientific bypass structure



	Panels		
Black	Packaging		
Charcoal	Displays quantity container		
Silver			
White			



European standard technology,
scientific bypass structure



MAGIC CUBE	Panels	600 e: 12 mm	900/800/600 x: 10panels	35kg	
Black	Packaging	850 500	3150	280 kg	
Charcoal	Displays quantity container	80	170	20 ft	40 ft
Silver					
White					

European standard technology,
scientific bypass structure



MAGIC CUBE	Panels	900 e: 12 mm	900 x: 8panels	35kg	
Black	Packaging	850 500	3150	300 kg	
Charcoal	Displays quantity container	80	170	20 ft	40 ft
Silver					
White					

Ceramic display rack global customization



MAGIC CUBE

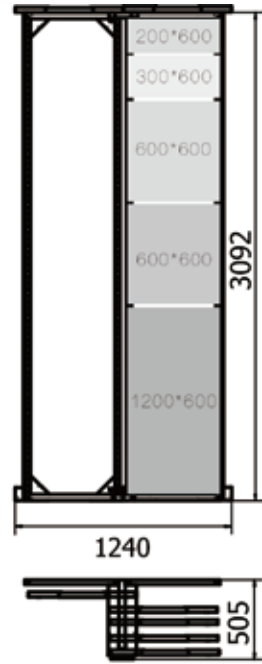

Original patent product



This series of exhibition shelves can be rotated, rotatable, independent, and can be combined, showing a variety of display effects.

European standard technology, scientific bypass structure



MAGIC CUBE	Panels	600 x 1000 e: 15 mm x: 10panels	60kg
Black	Packaging	850 x 3150 500	250 kg
Charcoal	Displays quantity container	8 20 ft	16 40 ft
Silver			
White			

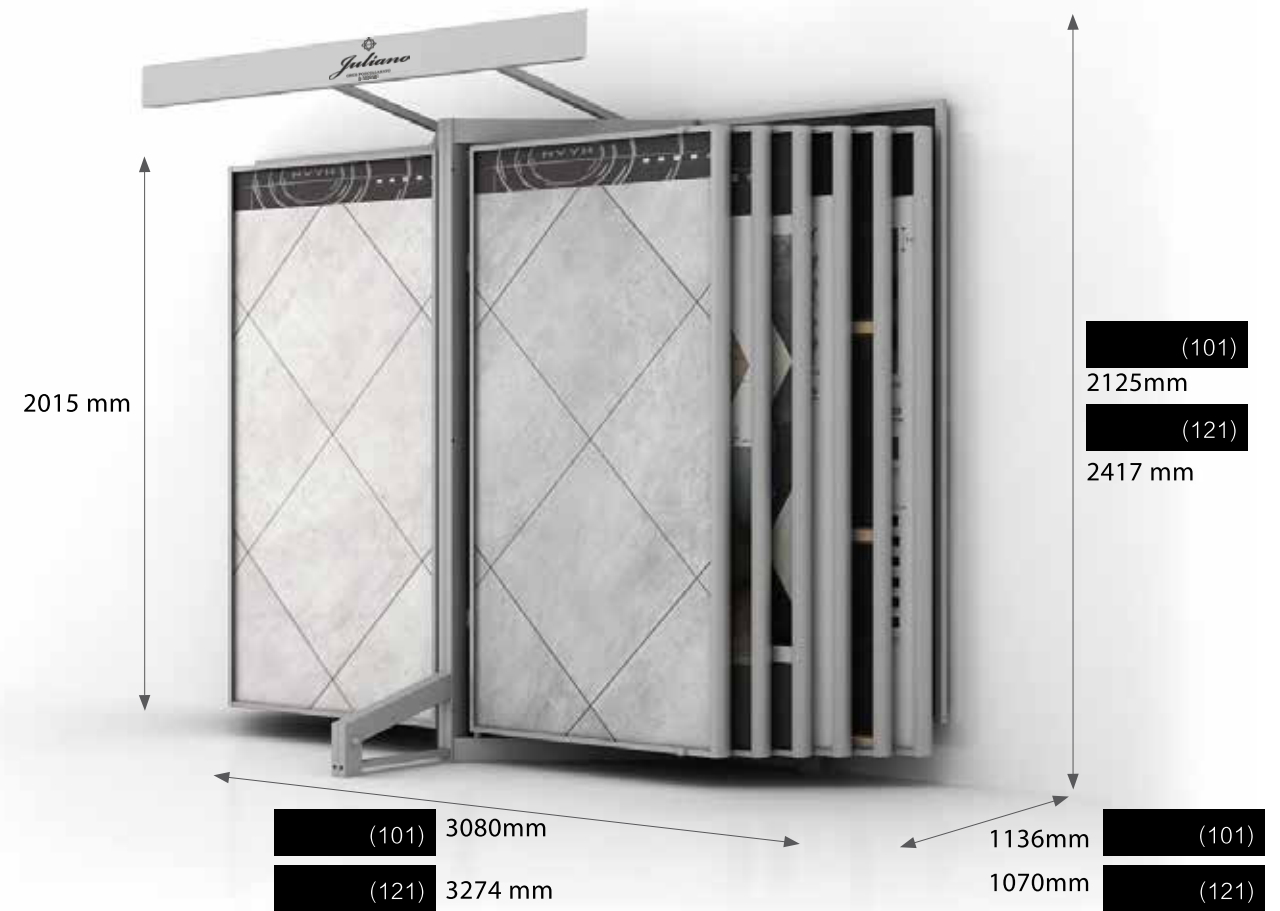

This exhibition rack does not need floor.

European standard technology,
scientific bypass structure



B1 CORNER(10P)			
Black			
Charcoal			
Silver			
White			
Panels	1210 e: 15 mm x: 10panels	2410	60kg
Packaging	570 1400	2690	360 kg
Displays quantity container	8 20 ft	16 40 ft	

European standard technology,
scientific bypass structure



Black			
Charcoal			
Silver			
White			
B1 18P(121)			
Panels	1006 e: 15 mm x: 26panels	1920	60 kg
Packaging	900 1155	2270	377 kg
Displays quantity container	12 20 ft	26 40 ft	
Panels	1210 e: 15 mm x: 18panels	2410	60 kg
Packaging	800 1400	2690	410 kg
Displays quantity container	4 20 ft	8 40 ft	



This exhibition rack does not need floor.

European standard technology,
scientific bypass structure



B1 48P PLUS			
Black			
Charcoal			
Silver			
White白色			
	Panels		
	Packaging		
	Displays quantity container		

European standard technology,
scientific bypass structure



B1 48P PLUS			
Black			
Charcoal			
Silver			
White			
	Panels		
	Packaging		
	Displays quantity container		

Ceramic display rack global customization

Original patent product



This exhibition rack does not need floor.

European standard technology,
scientific bypass structure



B4 CORNER(14)	Panels	1006 e: 15 mm 1920 x: 14 panels	60kg
Black	Packaging	730 1160 2290	270kg
Charcoal	Displays quantity container	15 20 ft	31 40 ft
Silver			
White			

European standard technology,
scientific bypass structure



	Panels	600 e: 15 mm 1920 x: 26panels	485kg
Black	Packaging	1150 1160 2300	60 kg
Charcoal	Displays quantity container	9 20 ft	19 40 ft
Silver			
White			

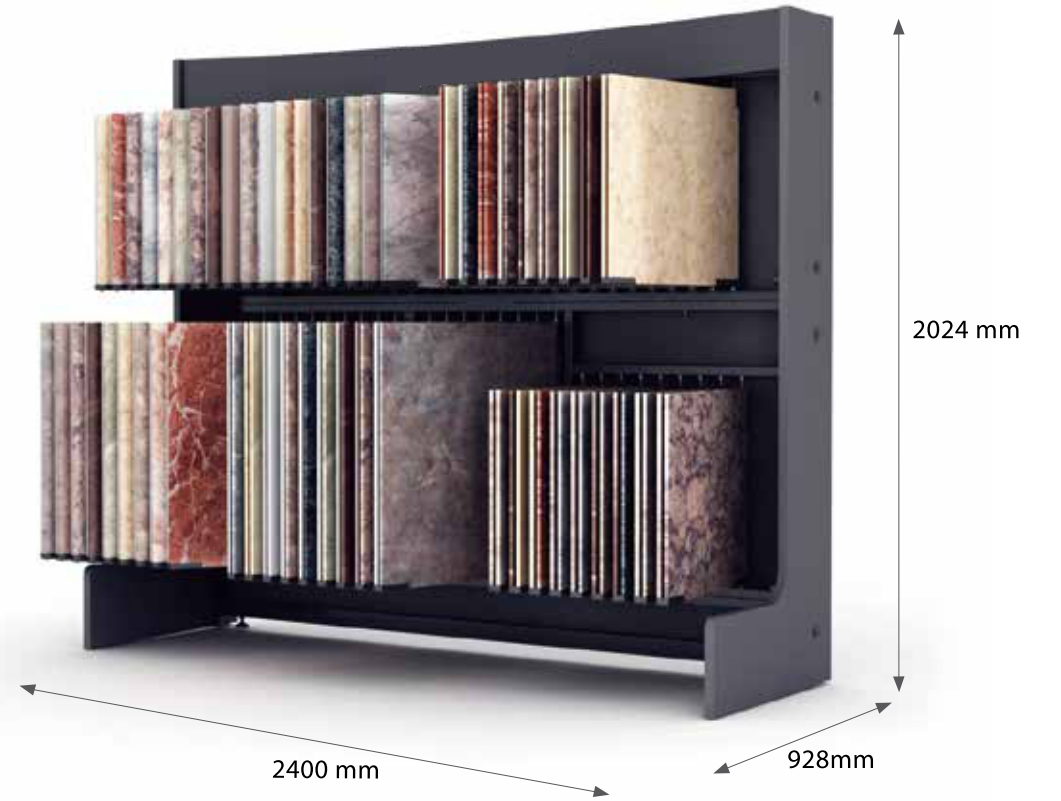
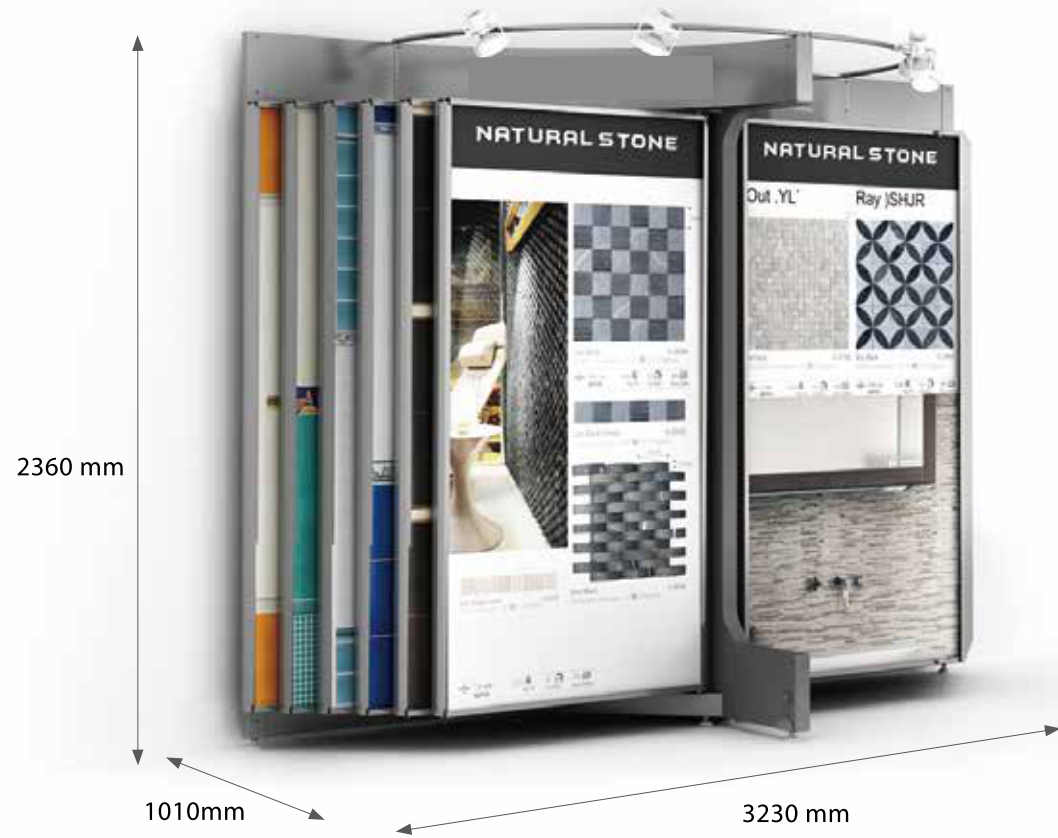

This exhibition rack does not need floor.

European standard technology,
scientific bypass structure



B4 DUAL OPTION B			
Black	Panels		60kg
Charcoal	Packaging		485kg
Silver	Displays quantity container		19
White			40 ft

European standard technology,
scientific bypass structure



B5-A			
Black	Panels		35kg
Charcoal	Packaging		334kg
Silver	Displays quantity container		15
White			40 ft

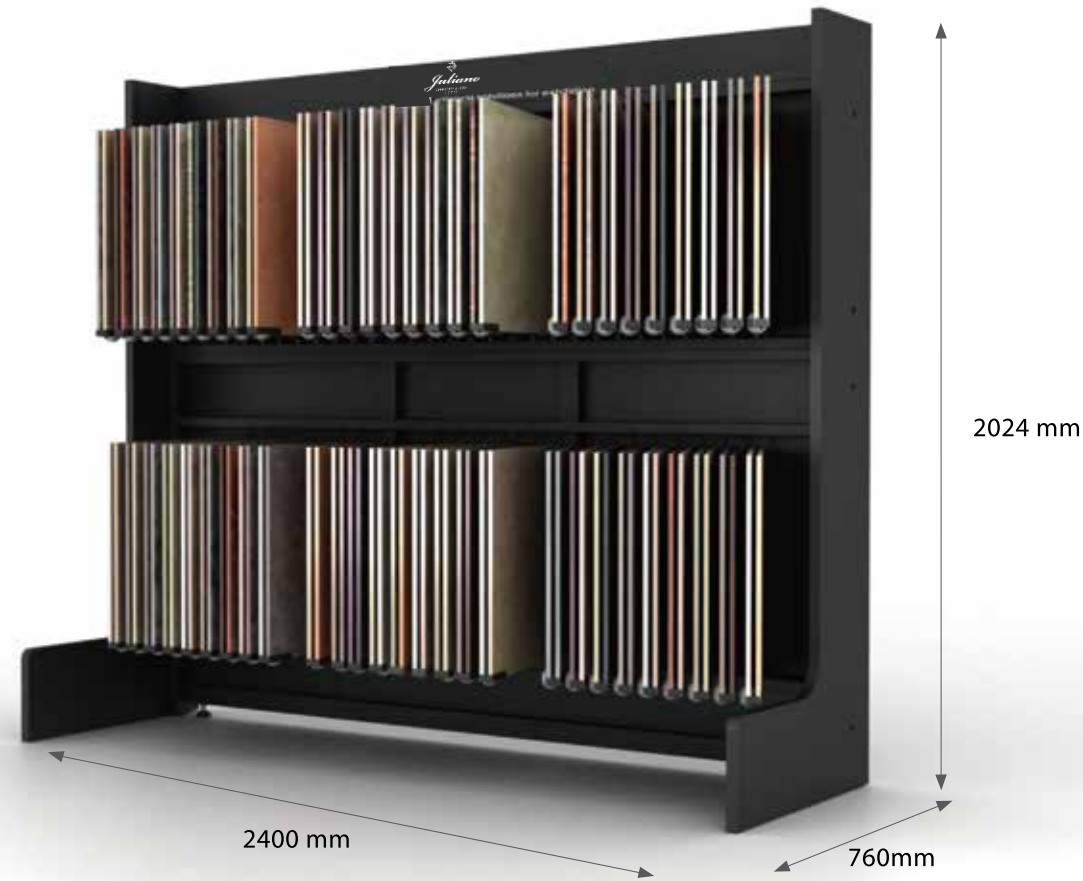

This exhibition rack does not need floor.

European standard technology,
scientific bypass structure



B5-B	Panels	600 e: 12 mm 600 x: 108 panels	35kg
Black	Packaging	1150 1160 2300	200kg
Charcoal	Displays quantity container	6 20 ft	15 40 ft
Silver银色			
White白色			

European standard technology,
scientific bypass structure



B5-B	Panels	900 e: 5.5 mm 1800 x: 16 panels	55kg
Black黑色	Packaging	880 295 1680	85 kg
Charcoal碳黑色	Displays quantity container	42 20 ft	91 40 ft
Silver银色			
White白色			

Ceramic display rack global customization

Original patent product

S SERIES

S, she's changeable and varied. The atmosphere is clear when she's exposed. The mystery is hidden when she's hidden. The way she's spinning, the way she's pushed and pulled makes you love her.



This exhibition rack does not need floor.

European standard technology, scientific bypass structure



S1 MIMI		
Black		
Charcoal		
Silver		
White		
Panels	600 e: 12 mm 2010 x: 12panels	20kg
Packaging	580 400 1280	146 kg
Displays quantity container	60 20 ft	120 40 ft



This exhibition rack does not need floor.

European standard technology,
scientific bypass structure



Color	Panels	Packaging	Displays quantity container
Black			
Charcoal			
Silver			
White			
(101)	1015 x 2010 e: 15 mm x: 14 panels 60 kg	570 x 2270 1155 x 278.5 kg	19 20 ft 39 40 ft
S1 12P+2T (121)	1215 x 2010 e: 15 mm x: 14 panels 60 kg	570 x 2610 1390 x 313 kg	6 20 ft 12 40 ft

European standard technology,
scientific bypass structure



Color	Panels	Packaging	Displays quantity container
S1 CON CEPT 14P	1015 x 2010 e: 15 mm x: 14 panels 60 kg		
Black			
Charcoal			
Silver			
White			
		570 x 2270 1155 x 250 kg	
			19 20 ft 39 40 ft

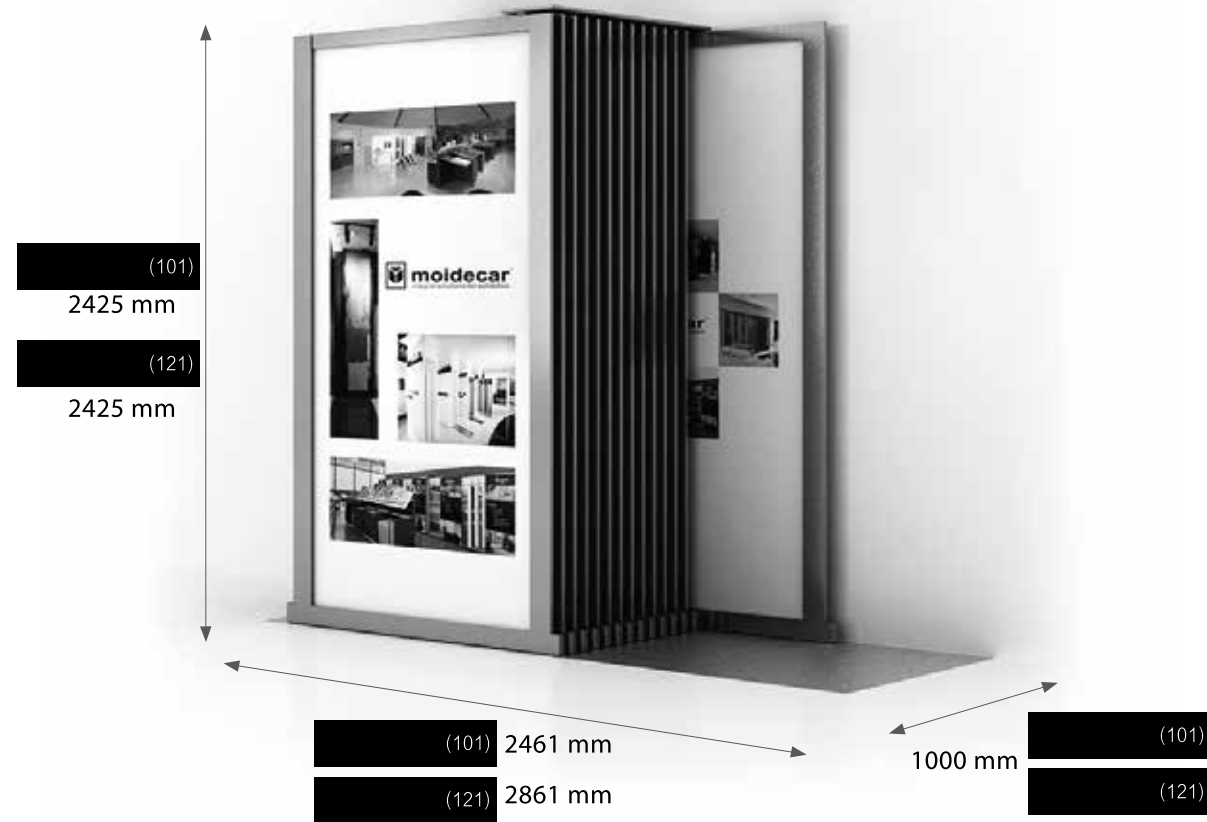

Fixed installation by wall

European standard technology,
scientific bypass structure



Color	Panels	Packaging	Displays quantity container
Black			
Charcoal			
Silver			
White			
S1 PLUS(121)			

Custom display height can be customized.

European standard technology,
scientific bypass structure



Color	Panels	Packaging	Displays quantity container
S1 MEGA PLUS			
Black			
Charcoal			
Silver			
White			

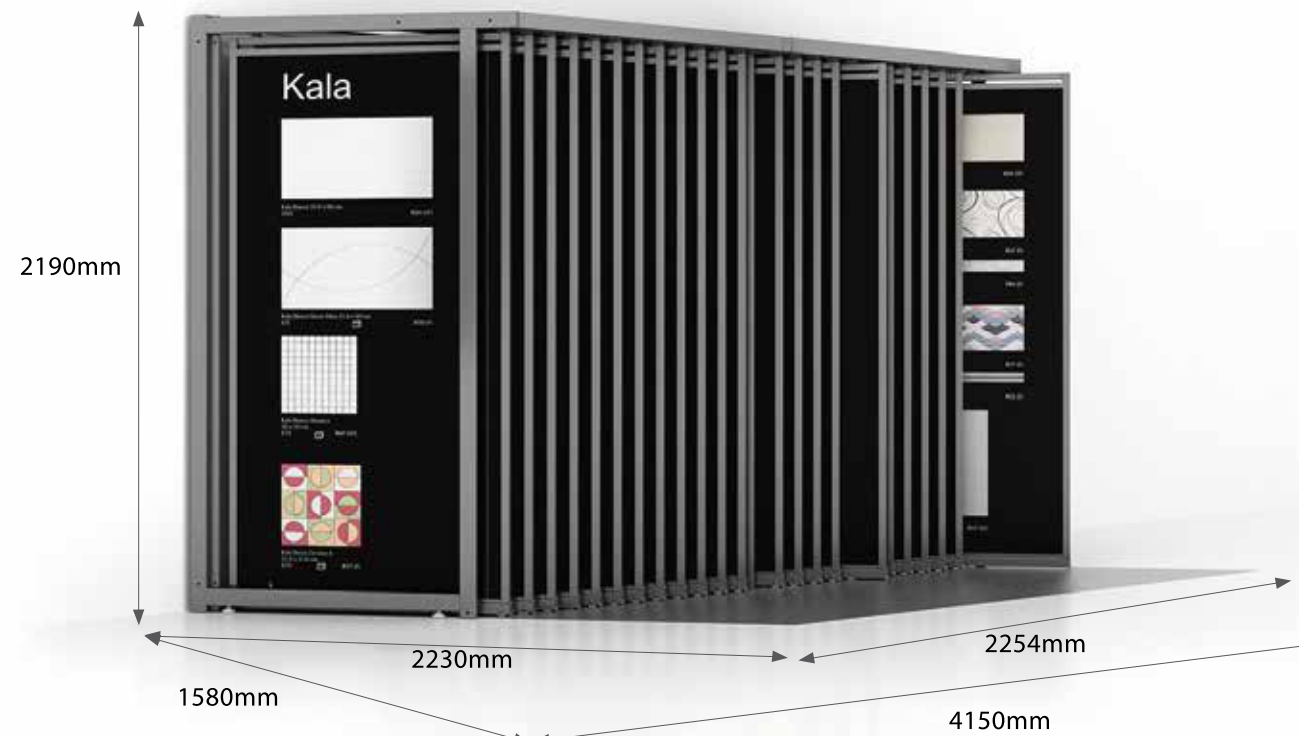

Fixed installation by wall

European standard technology,
scientific bypass structure



	Panels		
Black	Packaging		
Charcoal	Displays quantity container		
Silver			
White			

European standard technology,
scientific bypass structure



	Panels		
S10BLICUO(24P)	Packaging		
Black	Displays quantity container		
Charcoal			
Silver			
White			

S2 ROLLING

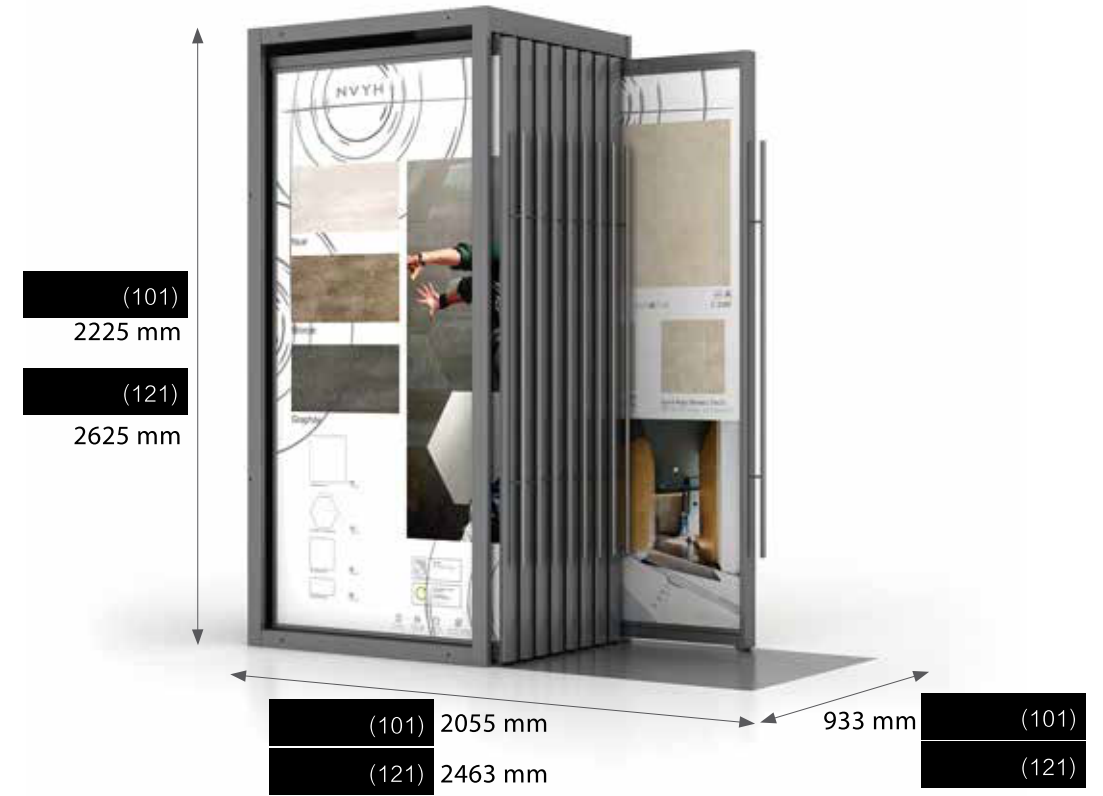

(4, 6, 8, 10, 12, 14) This exhibition rack does not need floor.

European standard technology,
scientific bypass structure



S2 ROLLING	Panels	1200 x 2010 e: 15 mm x: 14panels	60kg
Black Charcoal Silver White	Packaging	570 x 2270 1155	250 kg
	Displays quantity container	1 x 20 ft truck 3 x 40 ft truck	

European standard technology,
scientific bypass structure



Black Charcoal Silver White	Panels	Packaging	Displays quantity container
S2 18P (101)	1006 x 2010 e: 15 mm x: 18 panels 60 kg	980 x 2270 1155 432 kg	10 x 20 ft truck 22 x 40 ft truck
(121)	1210 x 2410 e: 15 mm x: 18 panels 80 kg	980 x 2670 1400 513 kg	4 x 20 ft truck 8 x 40 ft truck



European standard technology,
scientific bypass structure



S3 12P+2T(101)	Panels	1015 e: 15 mm 2010 x:14 panels	60kg
Black	Packaging	570 1155 2270	379 kg
Charcoal	Displays quantity container	20 20 ft	42 40 ft
Silver			
White			

European standard technology,
scientific bypass structure



S3 24P+3T(101)	Panels	1015 e: 15 mm 2010 x:27 panels	60kg
Black	Packaging	1220 1185 3335	621 kg
Charcoal	Displays quantity container	1 20 ft	3 40 ft
Silver			
White			



S1 14plus
2213 mm

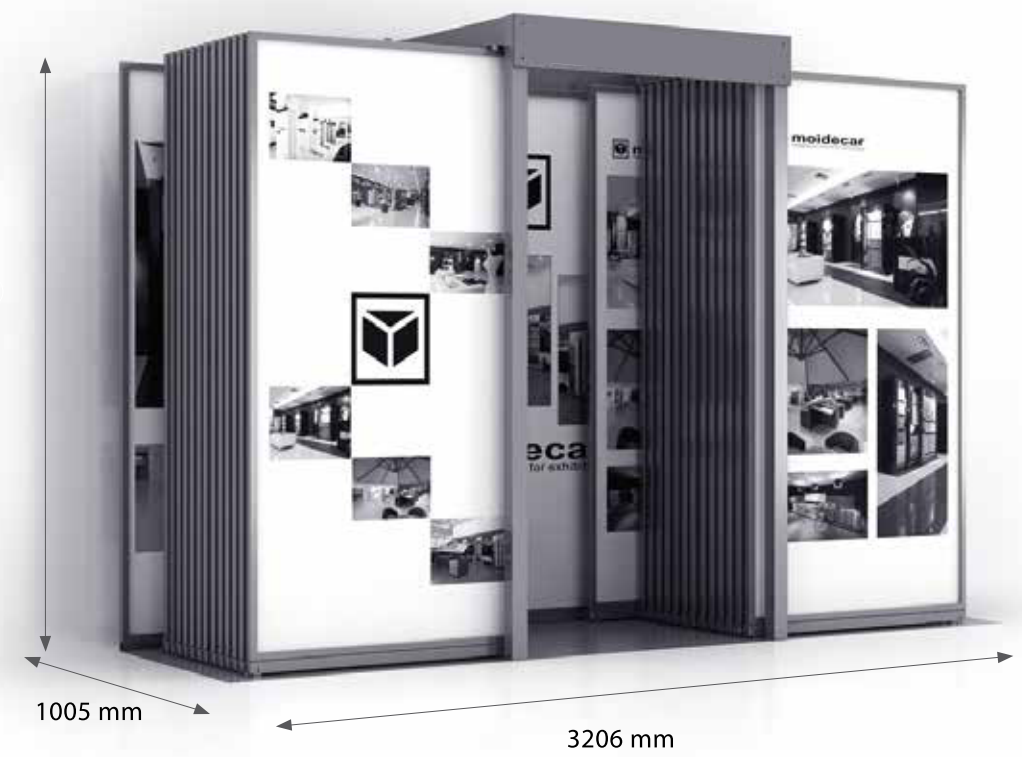

Fixed installation by wall

European standard technology,
scientific bypass structure



Color	Panels	Packaging	Displays quantity container
Black			
Charcoal			
Silver			
White			
S1 20P(101)			

Fixed installation by wall

European standard technology,
scientific bypass structure



Color	Panels	Packaging	Displays quantity container
S4 31P(101)			
Black			
Charcoal			
Silver			
White			

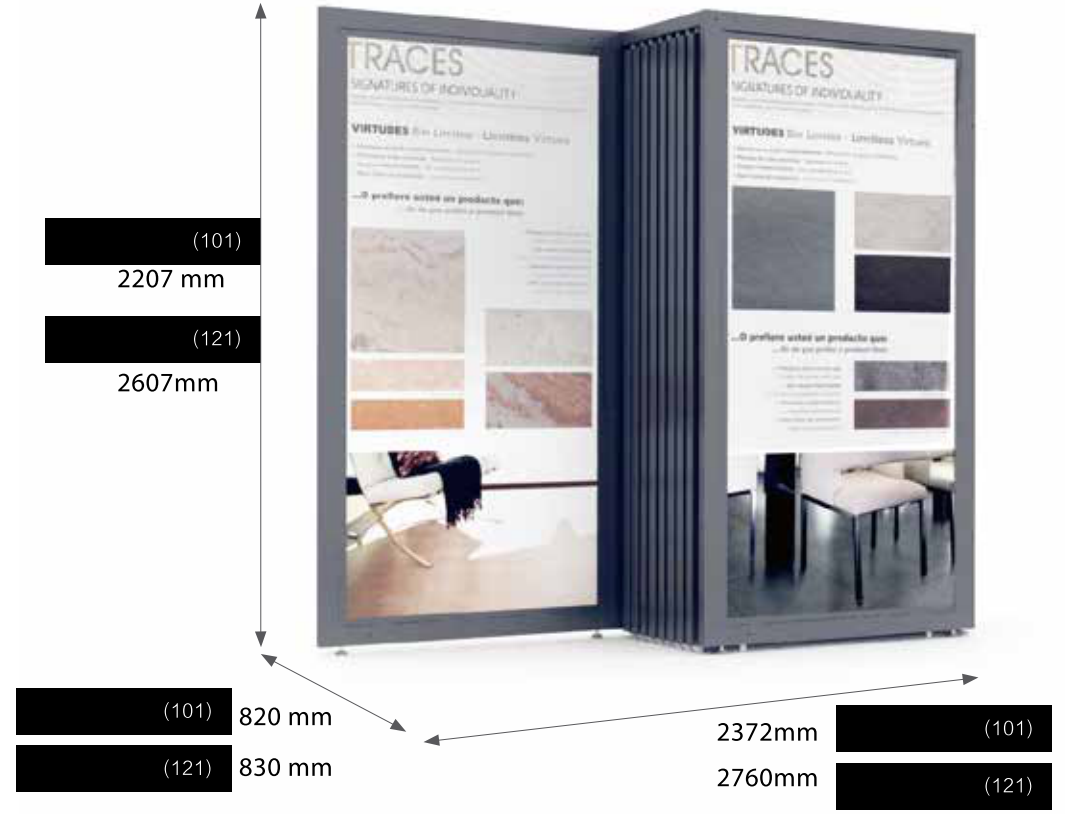

This includes the floor.

European standard technology, scientific bypass structure

- SCIENCE
- SECURITY
- PATENT
- QUALITY
- ECO
- CUSTOMIZED

S7(6P)	Panels	605 x 1810 e: 15 mm x:6 panels	30kg
Black Charcoal Silver White	Packaging	1300 x 2100 600	262 kg
	Displays quantity container	12 (20 ft) 27 (40 ft)	

European standard technology, scientific bypass structure

- SCIENCE
- SECURITY
- PATENT
- QUALITY
- ECO
- CUSTOMIZED

Black Charcoal Silver White	Panels	Packaging	Displays quantity container
S8-A 8P+2T (101)	1010 x 2010 e: 15 mm x: 10 panels 60 kg	1280 x 2290 710 300 kg	12 (20 ft) 27 (40 ft)
(121)	1210 x 2410 e: 15 mm x: 10 panels 72 kg	1480 x 2680 710 365 kg	4 (20 ft) 8 (40 ft)



European standard technology, scientific bypass structure



Color	Panels	Packaging	Displays quantity container
Black			
Charcoal			
Silver			
White			
S8-B16P+3T (101)	1010 x 2010 mm, e: 15 mm, x: 19 panels, 60 kg	1280 x 2290 mm, 1060 mm, 617 kg	8 (20 ft), 18 (40 ft)
S8 816P+3T (121)	1210 x 2410 mm, e: 15 mm, x: 19 panels, 72 kg	1480 x 2680 mm, 1060 mm, 770 kg	4 (20 ft), 8 (40 ft)

European standard technology, scientific bypass structure



Color	Panels	Packaging	Displays quantity container
Black			
Charcoal			
Silver			
White			
S8-C 16P(101)	1010 x 2010 mm, e: 15 mm, x: 16 panels, 72 kg	1280 x 2290 mm, 1100 mm, 364 kg	8 (20 ft), 18 (40 ft)
S8-C 16P(121)	1210 x 2410 mm, e: 15 mm, x: 16 panels, 72 kg	1480 x 2680 mm, 1100 mm, 770 kg	4 (20 ft), 8 (40 ft)

S8 SLANT12P



This exhibition rack does not need floor.

European standard technology,
scientific bypass structure



	Panels	Packaging	Displays quantity container
Black			
Charcoal			
Silver			
White			
S8 SLANT12P(101)			
S8 SLANT12P(121)			

European standard technology,
scientific bypass structure



	Panels	Packaging	Displays quantity container
LINK 12P 101			
Black			
Charcoal			
Silver			
White			

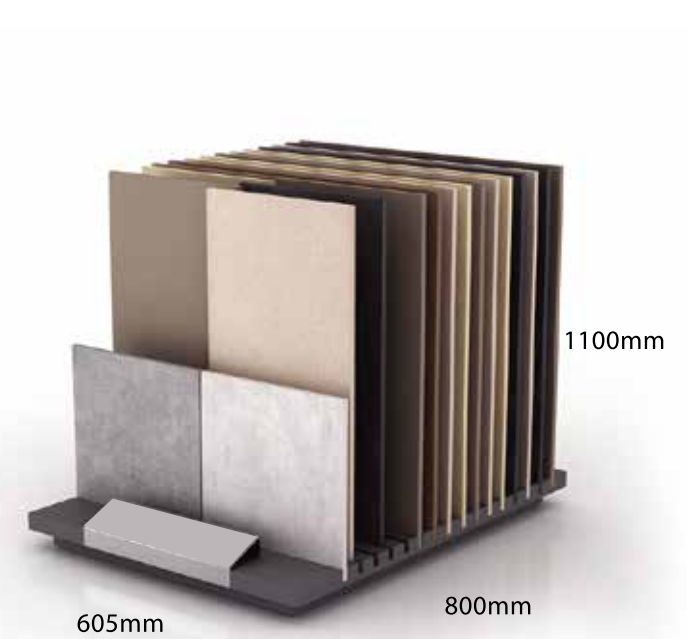
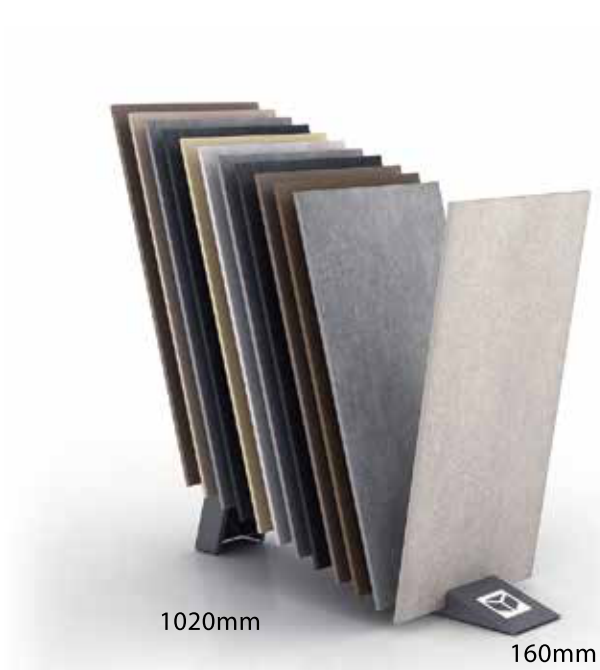
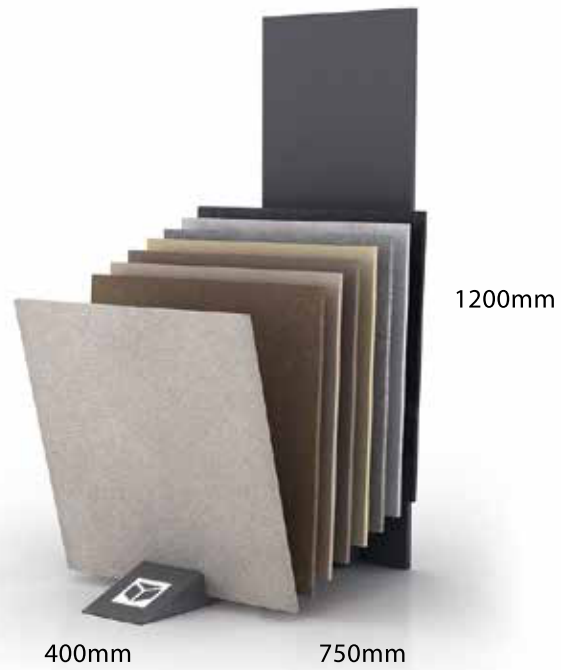

European standard technology,
scientific bypass structure

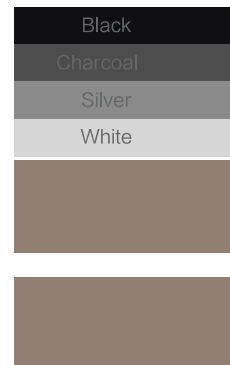

	Panels	Packaging	Displays quantity container
600/450	600/900	190 x 800	20 ft / 40 ft
x: 8 panels	e: 12 mm 9 kg	260 x 4 kg	
600	600	420 x 1220	20 ft / 40 ft
x: 8 panels	e: 12 mm 9 kg	200 x 13.5 kg	

European standard technology,
scientific bypass structure

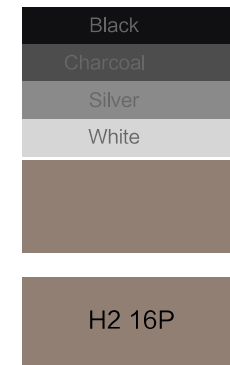

	Panels	Packaging	Displays quantity container
600/450	600/900	290 x 1040	20 ft / 40 ft
x: 12 panels	e: 12 mm 9 kg	170 x 6.5 kg	
600/300	600/300	620 x 820	20 ft / 40 ft
x: 16 panels	e: 12 mm 80 kg	115 x 19 kg	

Ceramic display rack global customization

Original patent product

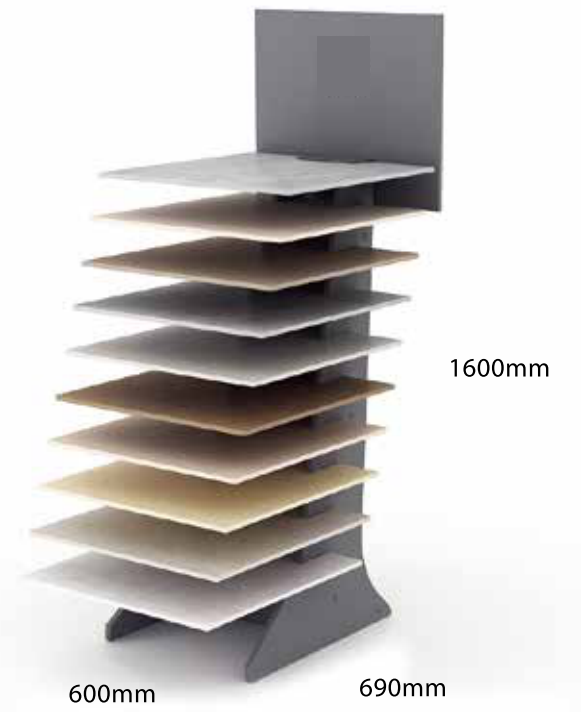
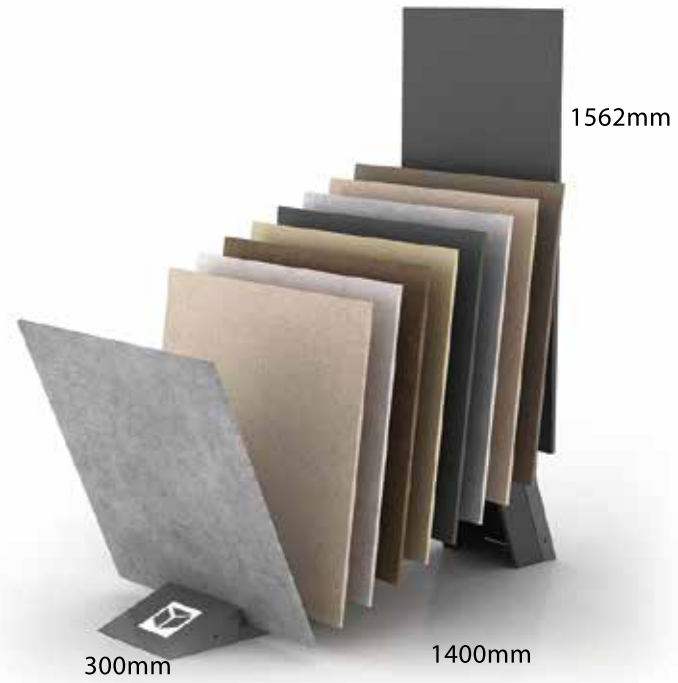

European standard technology,
scientific bypass structure

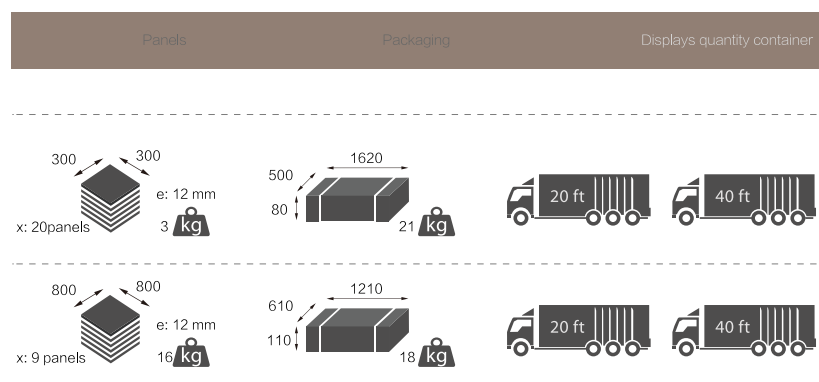
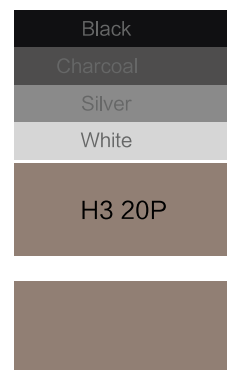

European standard technology,
scientific bypass structure

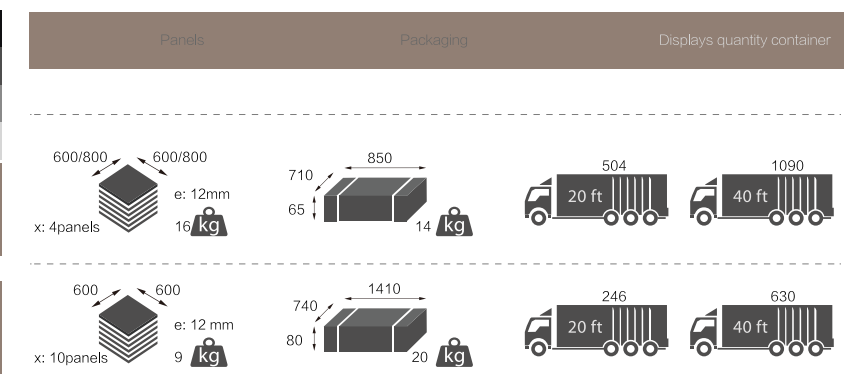
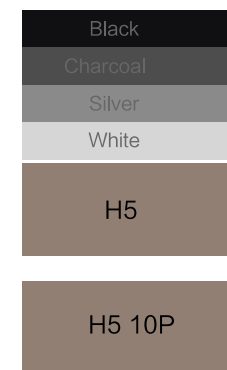

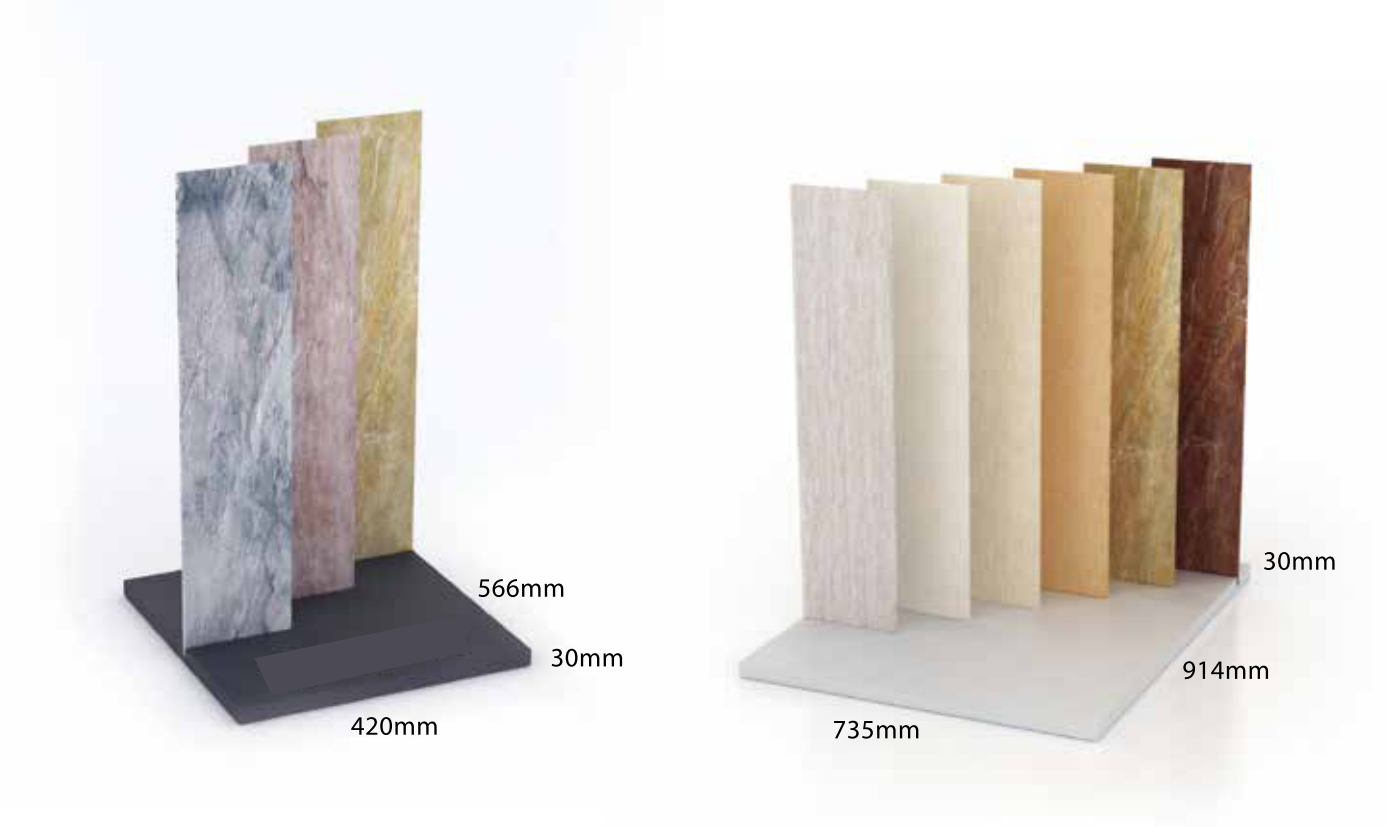

European standard technology, scientific bypass structure



Color	Panels	Packaging	Displays quantity container
Black			
Charcoal			
Silver			
White			
H7	1900 x 1800 e: 12 mm x: 1 panels 9 kg	870 x 670 105 x 18 kg	20 ft truck 40 ft truck
	600/300 x 300 e: 12 mm x: 10 panels 9 kg	970 x 1910 50 x 50 kg	20 ft truck 40 ft truck 330

European standard technology, scientific bypass structure



Color	Panels	Packaging	Displays quantity container
Black			
Charcoal			
Silver			
White			
H10	200 x 600 e: 12 mm x: 3 panels 6 kg	576 x 430 30 x 6 kg	20 ft truck 40 ft truck
H10 6P	200 x 600 e: 12 mm x: 6 panels 16 kg	924 x 745 30 x 16 kg	20 ft truck 40 ft truck



European standard technology,
scientific bypass structure

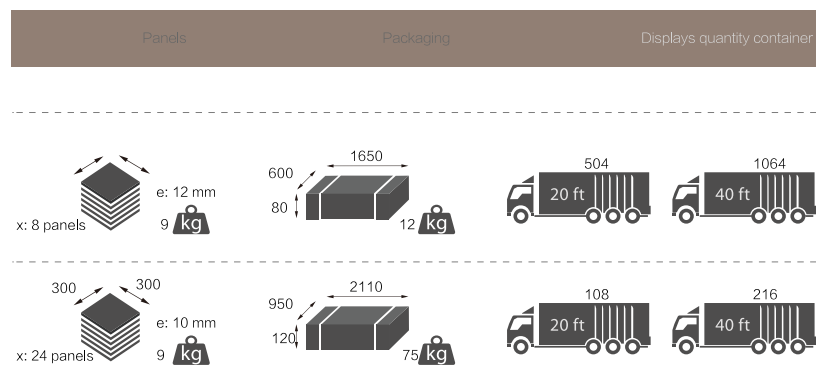
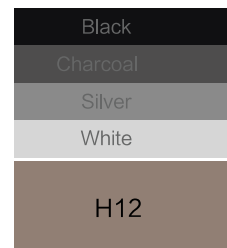

European standard technology,
scientific bypass structure

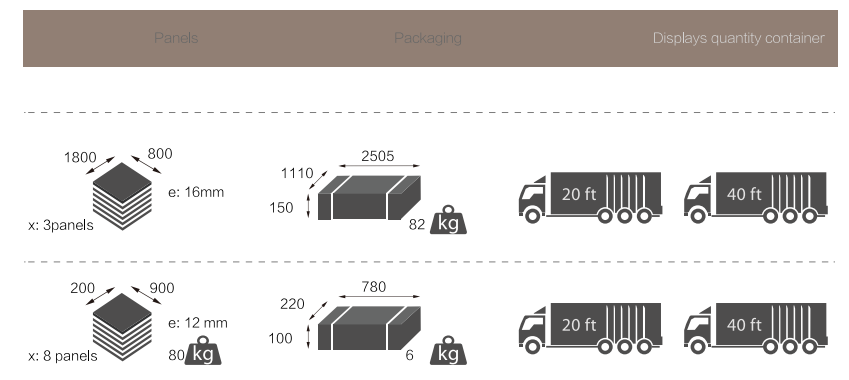
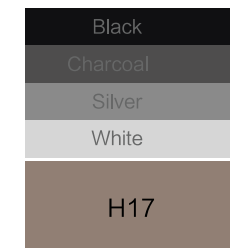

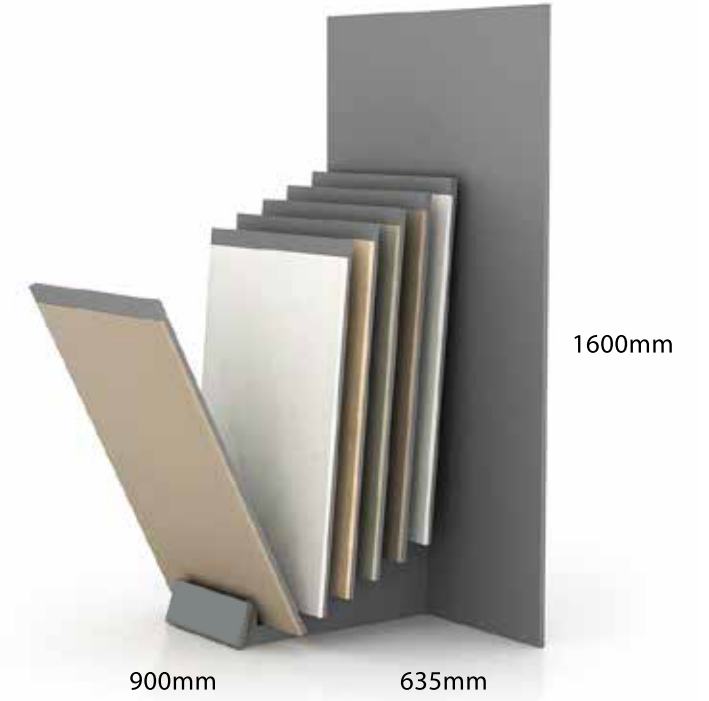
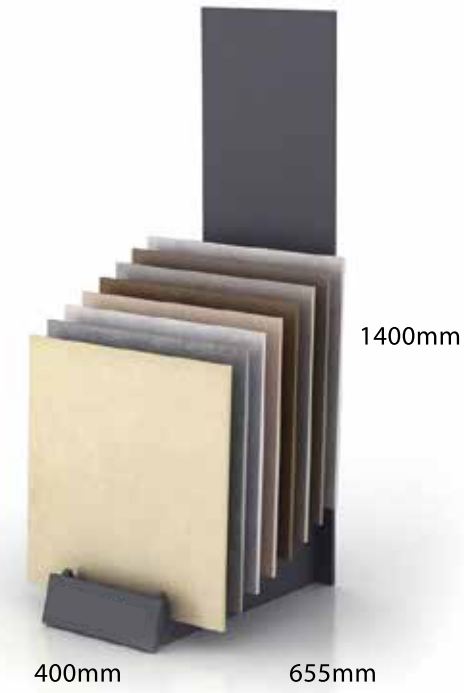
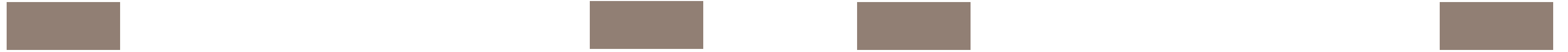

European standard technology,
scientific bypass structure

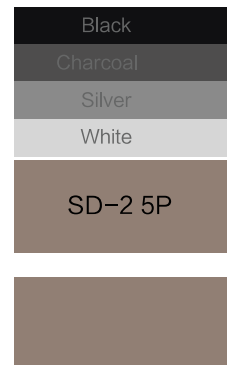

	Panels	Packaging	Displays quantity container	
SD-2 5P	<p>x: 5 panels e: 16 mm 9 kg</p>	<p>450 830 400 34 kg</p>		
	<p>x: 4panels e: 16 mm 9 kg</p>	<p>880 780 400 51 kg</p>		

European standard technology,
scientific bypass structure

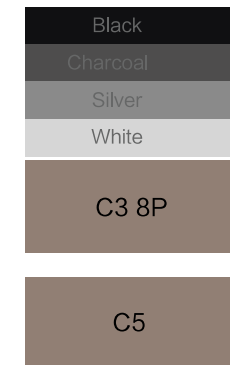

	Panels	Packaging	Displays quantity container	
C3 8P	<p>x: 8 panels e: 12 mm 9 kg</p>	<p>450 1440 70 17 kg</p>		
C5	<p>x: 6 panels e: 12 mm 20 kg</p>	<p>980 1680 310 112 kg</p>		



900 mm 650 mm

1600 mm



400mm 654mm

350mm



870mm 600mm

1500mm



400mm 625mm

700mm

European standard technology,
scientific bypass structure



- Black
- Charcoal
- Silver
- White
- C6 8P
- C7 5P

	Panels	Packaging	Displays quantity container	
C6 8P	 x: 8 panels 9 kg	 25 kg	 60	 120
C7 5P	 x: 5 panels 9 kg	 8 kg	 1008	 2016

European standard technology,
scientific bypass structure



- Black
- Charcoal
- Silver
- White
- C11

	Panels	Packaging	Displays quantity container	
C11	 x: 8 panels	 82 kg	 45	 105
C11	 x: 8 panels	 45 kg	 4	 8

Ceramic display rack global customization

Original patent product



810mm

1000 mm

670 mm

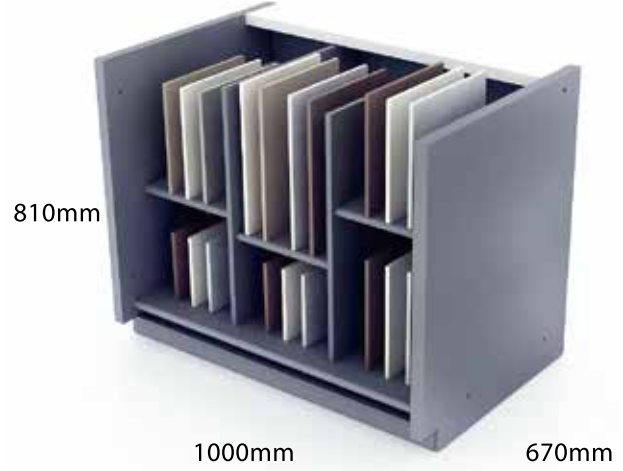

810mm

1000mm

670mm

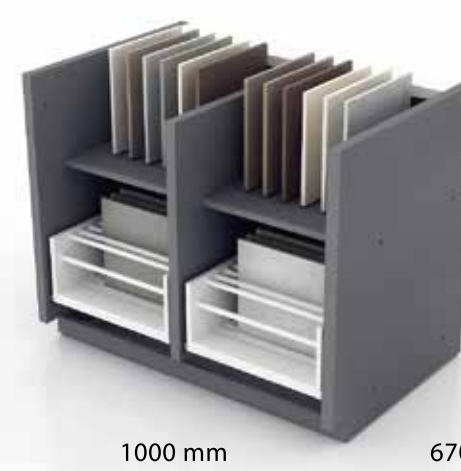

810mm

1000 mm

670 mm

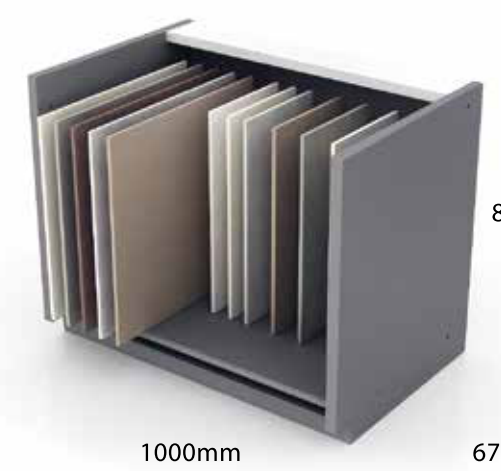

810mm

1000mm

670mm

European standard technology,
scientific bypass structure



- Black
- Charcoal
- Silver
- White



Panels	Packaging	Displays quantity container

European standard technology,
scientific bypass structure

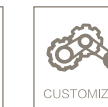

- Black
- Charcoal
- Silver
- White



Panels	Packaging	Displays quantity container

Ceramic display rack global customization

Original patent product

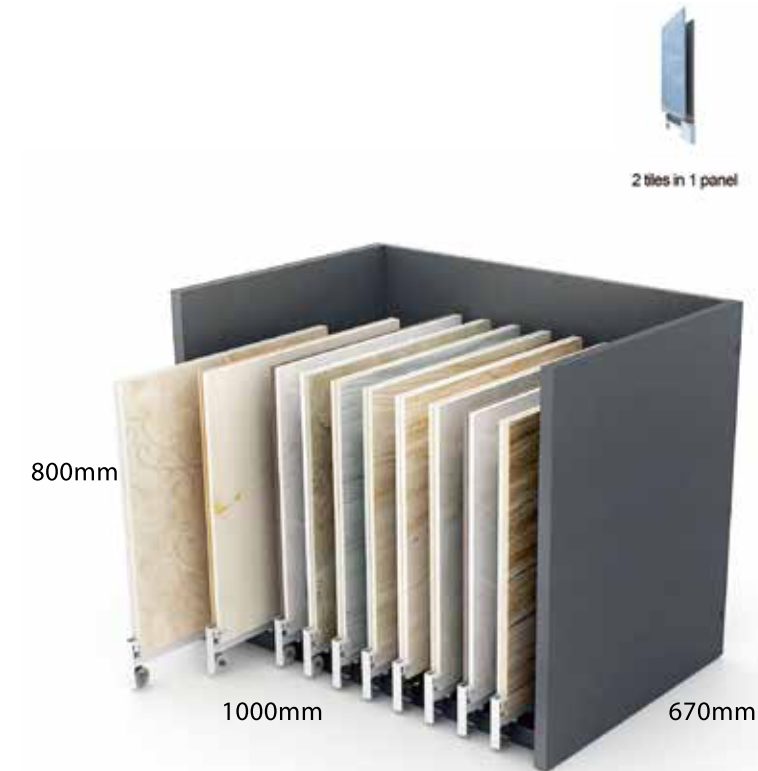
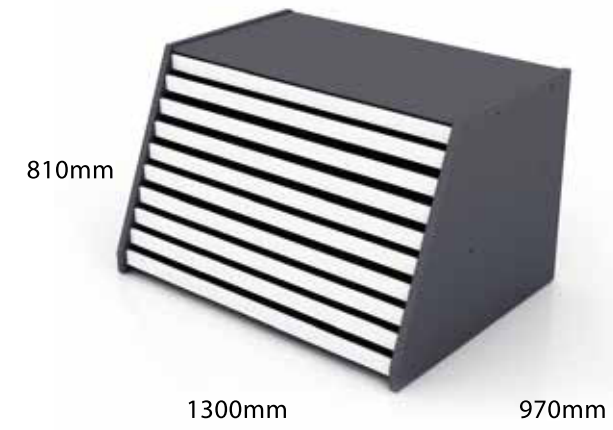
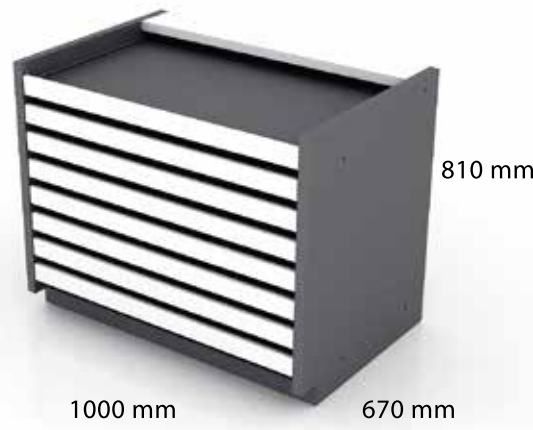

European standard technology,
scientific bypass structure

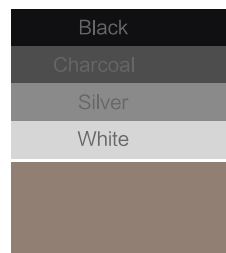

	Panels	Packaging	Displays quantity container
Black, Charcoal, Silver, White	 x: 8 panels e: 12 mm 9 kg	 173.5 kg	
	 x: 5 panels e: 12 mm 18 kg	 283 kg	

European standard technology,
scientific bypass structure



	Panels	Packaging	Displays quantity container
Black, Charcoal, Silver, White	 x: 20 panels e: 15 mm 110 kg	 110 kg	
TA-F	 x: 40 panels e: 12 mm 234 kg	 234 kg	

Ceramic display rack global customization

Original patent product

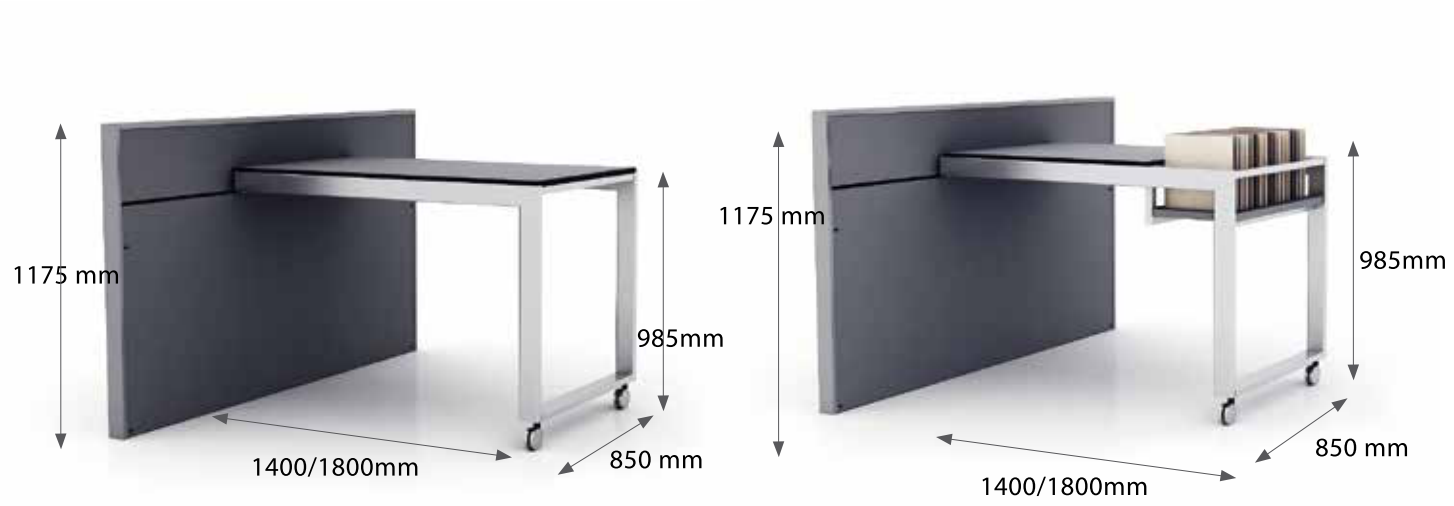

European standard technology,
scientific bypass structure

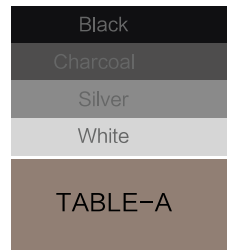

	Panels	Packaging	Displays quantity container
TABLE-A			
TABLE-B			

European standard technology,
scientific bypass structure

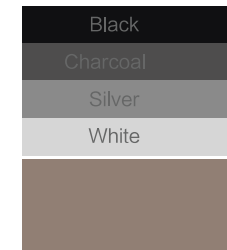

	Panels	Packaging	Displays quantity container
TABLE-A			
TABLE-B			



European standard technology,
scientific bypass structure



TENHNICAL-C			
Black			
Charcoal			
Silver			
C75P			
White白			
Panels			
Packaging			
Displays quantity container			

European standard technology,
scientific bypass structure



TENHNICAL-C			
Black			
Charcoal			
Silver			
White			
Panels			
Packaging			
Displays quantity container			

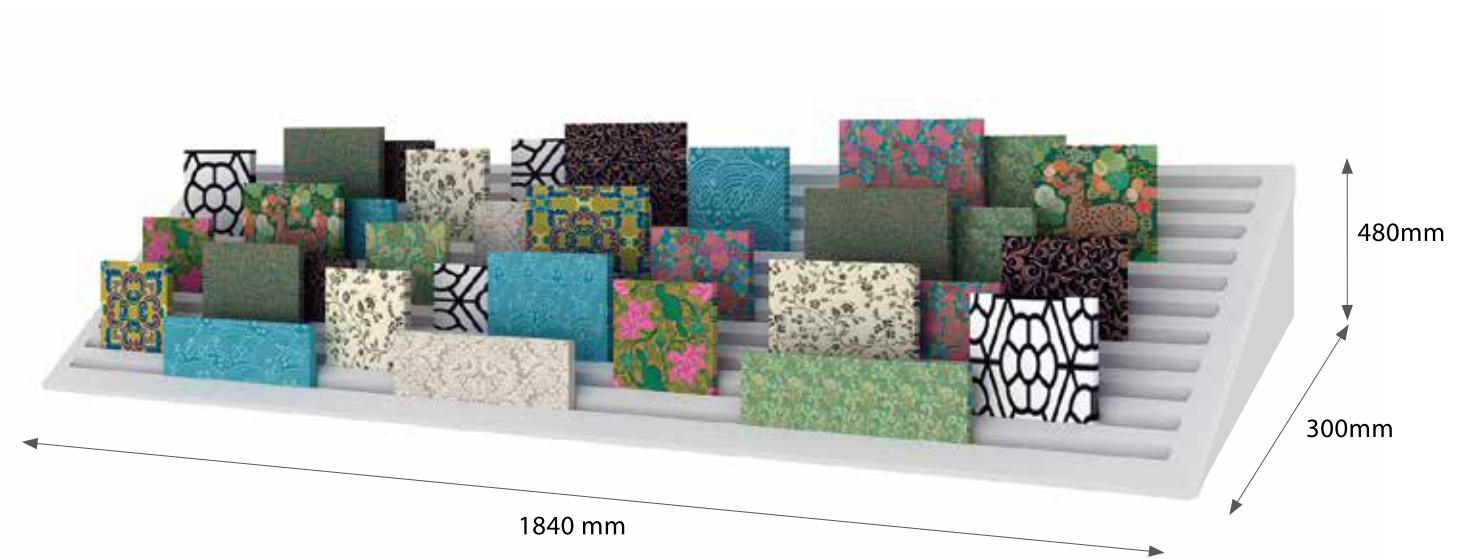
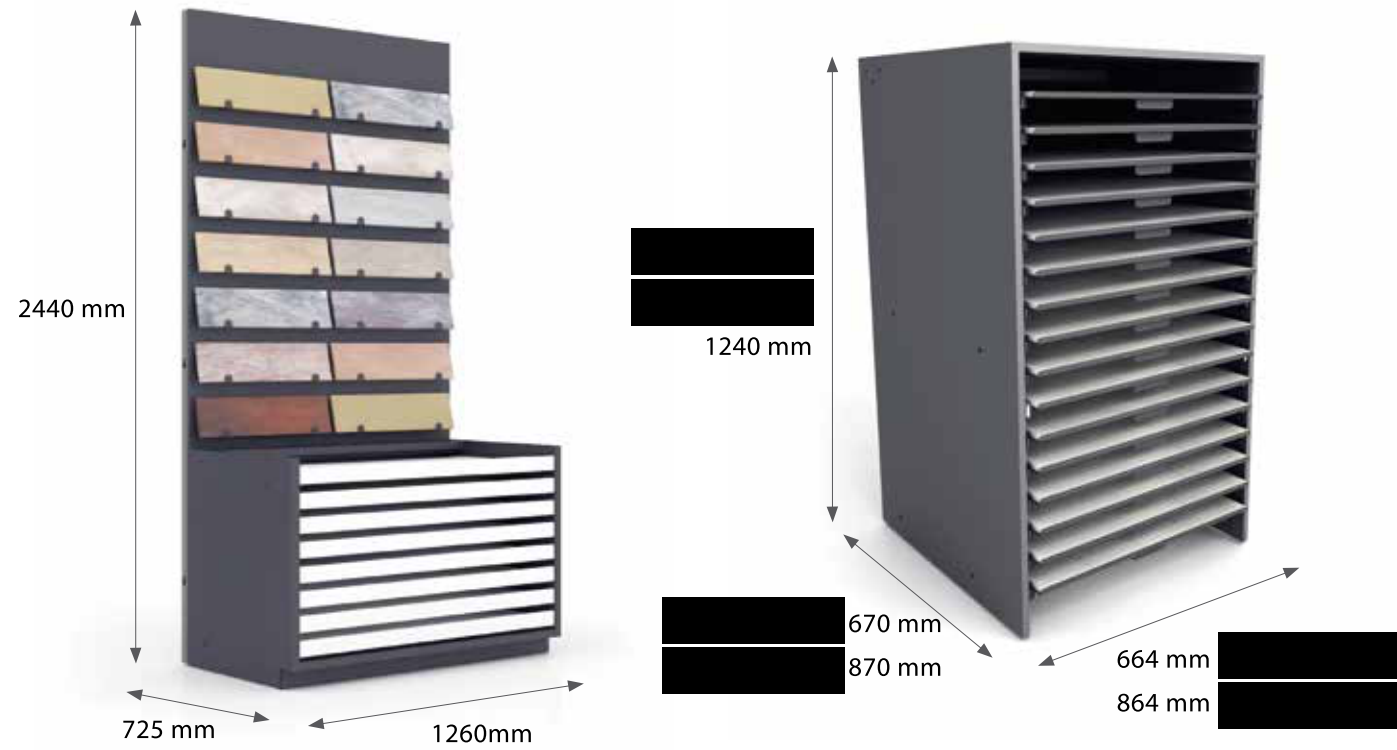

European standard technology,
scientific bypass structure



	Panels	Packaging	Displays quantity container
Black Charcoal Silver White TENHNICAL-E			

European standard technology,
scientific bypass structure



	Panels	Packaging	Displays quantity container
PIECE HOLDER			
Black黑色			
Charcoal碳黑色			
Silver银色			
White白色			

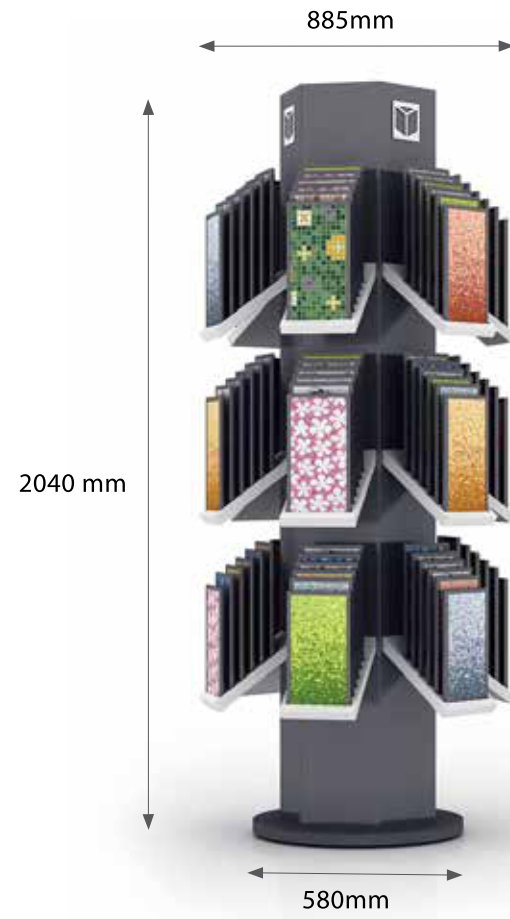

European standard technology,
scientific bypass structure



TURNING HOLDER			
Black			
Charcoal			
Silver			
White			
Panels	170 e: 10 mm 340 x: 108panels		0.5kg
Packaging	880 400 2060		148 kg
Displays quantity container	30 20 ft		65 40 ft

European standard technology,
scientific bypass structure



TOWER			
Black			
Charcoal			
Silver			
White			
Panels	400 e: 16 mm 2000 x: 4panels		16kg
Packaging	640 280 2060		128 kg
Displays quantity container	63 20 ft		126 40 ft

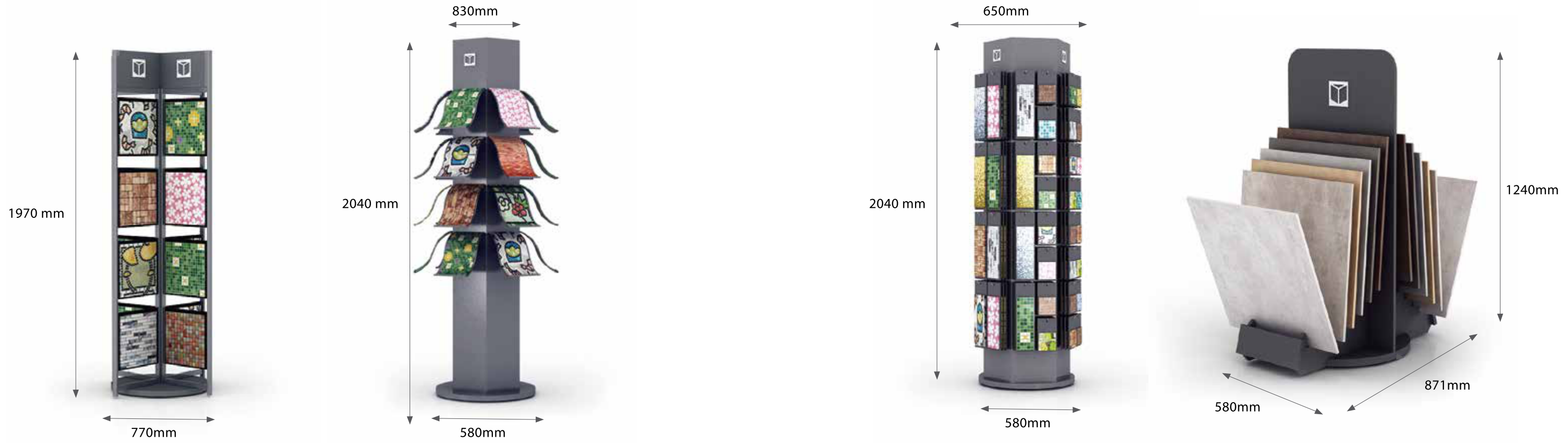

European standard technology,
scientific bypass structure

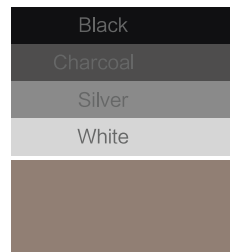

	Panels	Packaging	Displays quantity container	
300x300 for mosaic	x: 16panels	3 kg	850x2060x250, 100 kg	154 (20 ft), 66 (40 ft)
200x300 for mosaic	x: 24panels	1.5 kg	880x2060x400, 150 kg	30 (20 ft), 65 (40 ft)

European standard technology,
scientific bypass structure

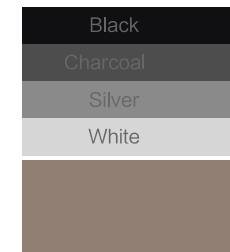

	Panels	Packaging	Displays quantity container	
100/300 e: 15 mm	x: 96panels	3 kg	850x2060x250, 100 kg	66 (20 ft), 154 (40 ft)
600x600 e: 12 mm	x: 12panels	9 kg	600x1220x100, 26.2 kg	180 (20 ft), 380 (40 ft)



European standard technology,
scientific bypass structure



- Black
- Charcoal
- Silver
- White
- CORFU 101+9T

Color	Panels	Packaging	Displays quantity container
Black	300/600 x: 19panels 4(9T) 9(10T) kg	850 550 2290 223 kg	23 51 20 ft 40 ft
Charcoal	600/1200 x: 20/10panels e: 12 mm 9 kg	700 350 2290 156.5 kg	48 96 20 ft 40 ft

European standard technology,
scientific bypass structure



- Black
- Charcoal
- Silver
- White
- CRETA 10T
- KRONOS

Color	Panels	Packaging	Displays quantity container
Black	600 x: 10panels e: 12 mm 9 kg	850 450 2290 193 kg	24 65 20 ft 40 ft
Charcoal	650(65) 850(85) x: 8panels e: 12 mm 24(65) 30(85) kg	760(65) 500 960(85) 2290 307(65) 380(85) kg	28(65) 24(85) 60(65) 48(85) 20 ft 40 ft



European standard technology,
scientific bypass structure



Black	Panels	605 e: 16 mm	1875 x: 24panels	30 kg
Black	Packaging	connect to Technical area		41 kg
Charcoal	Displays quantity container	connect to Technical area	20 ft	connect to Technical area
Silver				
White				

European standard technology,
scientific bypass structure



Color	Panels	Packaging	Displays quantity container
Black			
Charcoal			
Silver			
White			
	530 x: 14panels	730 e: 16 mm 10 kg	2290 1050 360 188 kg
	300 x: 23panels	300 1.5 kg	2290 1250 300 187 kg
			29 20 ft
			65 40 ft
			25 20 ft
			60 40 ft



Fixed installation by wall

European standard technology,
scientific bypass structure



- Black
- Charcoal
- Silver
- White
- SHOW ME WALL

- MENORCA

	Panels	Packaging	Displays quantity container	
SHOW ME WALL	600 x 600 mm e: 12 mm x: 6panels	700 x 2290 mm 250 mm height 139 kg	71 units / 20 ft truck	142 units / 40 ft truck
MENORCA	605 x 1875 mm e: 16 mm x: 12panels	700 x 2290 mm 500 mm height 251 kg	32 units / 20 ft truck	64 units / 40 ft truck

European standard technology,
scientific bypass structure



- Black
- Charcoal
- Silver
- White
- S-T

- S-T2

	Panels	Packaging	Displays quantity container	
S-T	850 x 2060 mm 250 mm height 38 kg	850 x 2060 mm 250 mm height 38 kg	connect to show me series 20 ft truck	40 ft truck
S-T2	880 x 2060 mm 400 mm height 38 kg	880 x 2060 mm 400 mm height 38 kg	connect to show me series 20 ft truck	40 ft truck



European standard technology,
scientific bypass structure



- Black
- Charcoal
- Silver
- White
- S-T1 BL
- S-T2 BL

	Panels	Packaging	Displays quantity container
S-T1 BL			
S-T2 BL			

European standard technology,
scientific bypass structure



- Black
- Charcoal
- Silver
- White
- S-T1 BR
- S-T2 BR

	Panels	Packaging	Displays quantity container
S-T1 BR			
S-T2 BR			

Ceramic display rack global customization

Original patent product

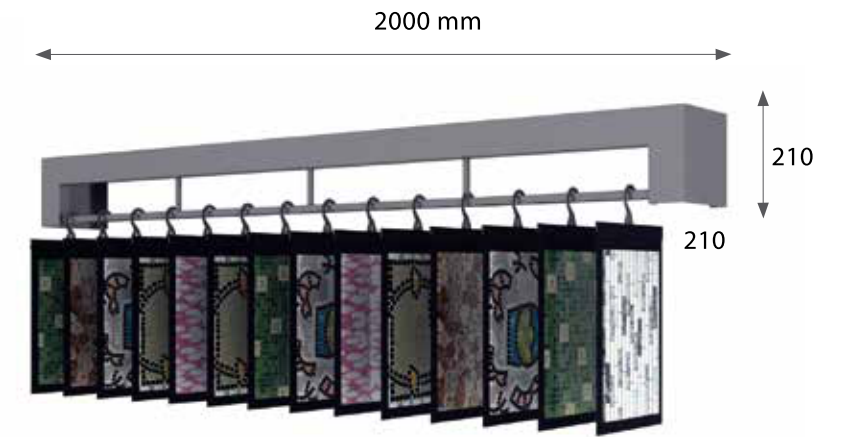
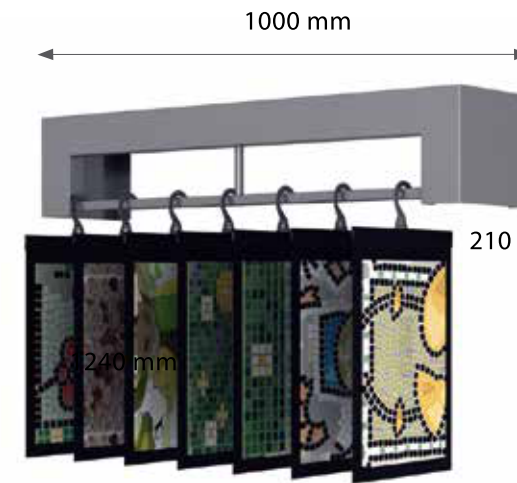
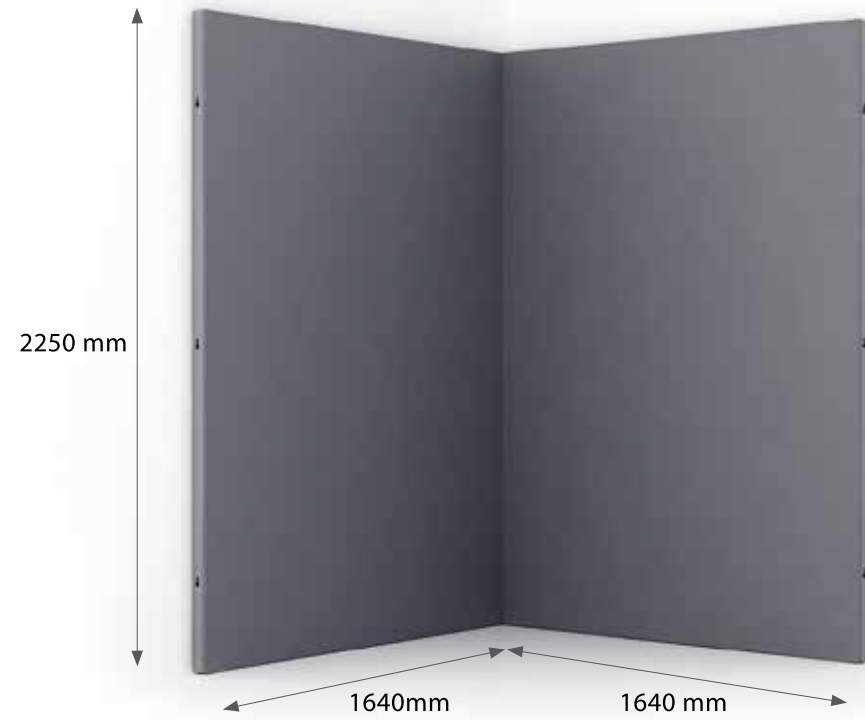

European standard technology,
scientific bypass structure



- SHOW ME CORNER
- Black
- Charcoal
- Silver
- White

Panels	e: 16 mm		
Packaging	1050 x 2290 x 900		250 kg
Displays quantity container	10 (20 ft) / 22 (40 ft)		

European standard technology,
scientific bypass structure



- Black
- Charcoal
- Silver
- White

Panels	Packaging	Displays quantity container
x: 16panels for mosaic 3 kg	connect to show me series 850 x 250 x 5,6 kg	connect to show me series 20 ft / 40 ft
x: 24panels for mosaic 1,5 kg	200 x 300 x 240 x 330 2050 x 38 kg	connect to show me series 20 ft / 40 ft

Ceramic display rack global customization

Original patent product

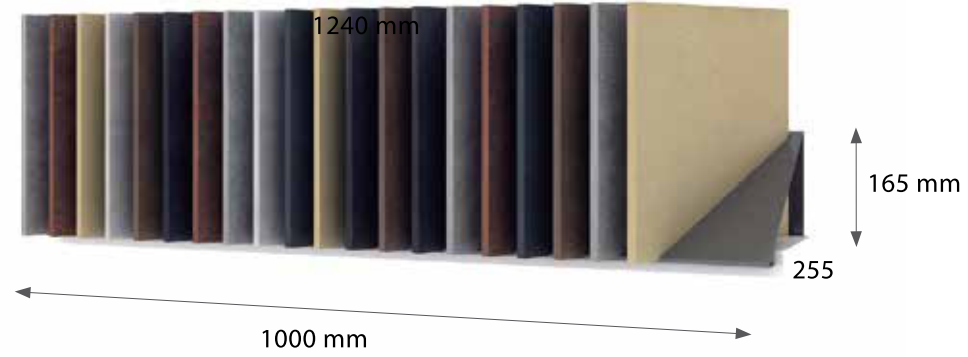
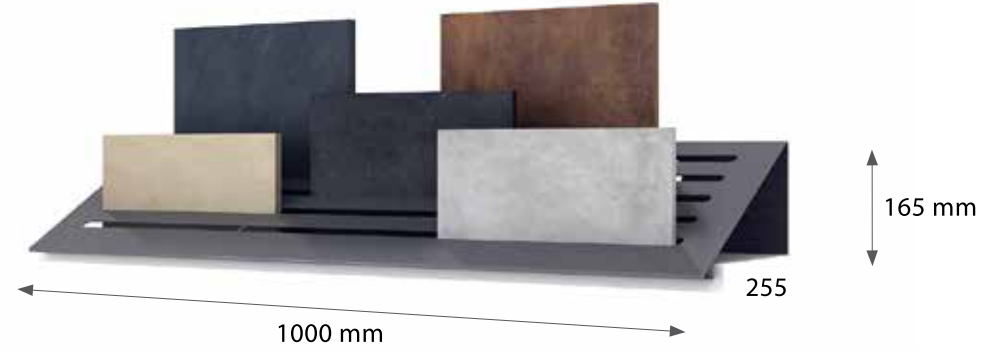

300X300(2.1kg)
600X600(3.2kg)
800X800(6.4kg)

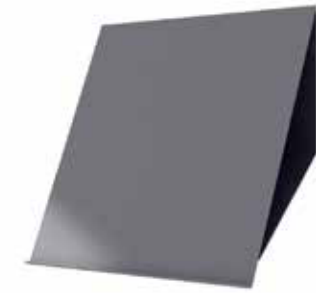

European standard technology, scientific bypass structure



	Panels	Packaging	Displays quantity container
Black			
Charcoal			
Silver			
White			
HOLDER A	x: 16panels 3 kg	kg	20 ft 40 ft
HOLDER B	x: 24panels 1.5 kg	kg	20 ft 40 ft

European standard technology, scientific bypass structure



	Panels	Packaging	Displays quantity container
Black			
Charcoal			
Silver			
White			
	300 300 for mosaic x: 16panels 3 kg	connect to show me series kg	connect to show me series 20 ft 40 ft
	200 300 x: 24panels 1.5 kg	connect to show me series 150 kg	connect to show me series 20 ft 40 ft

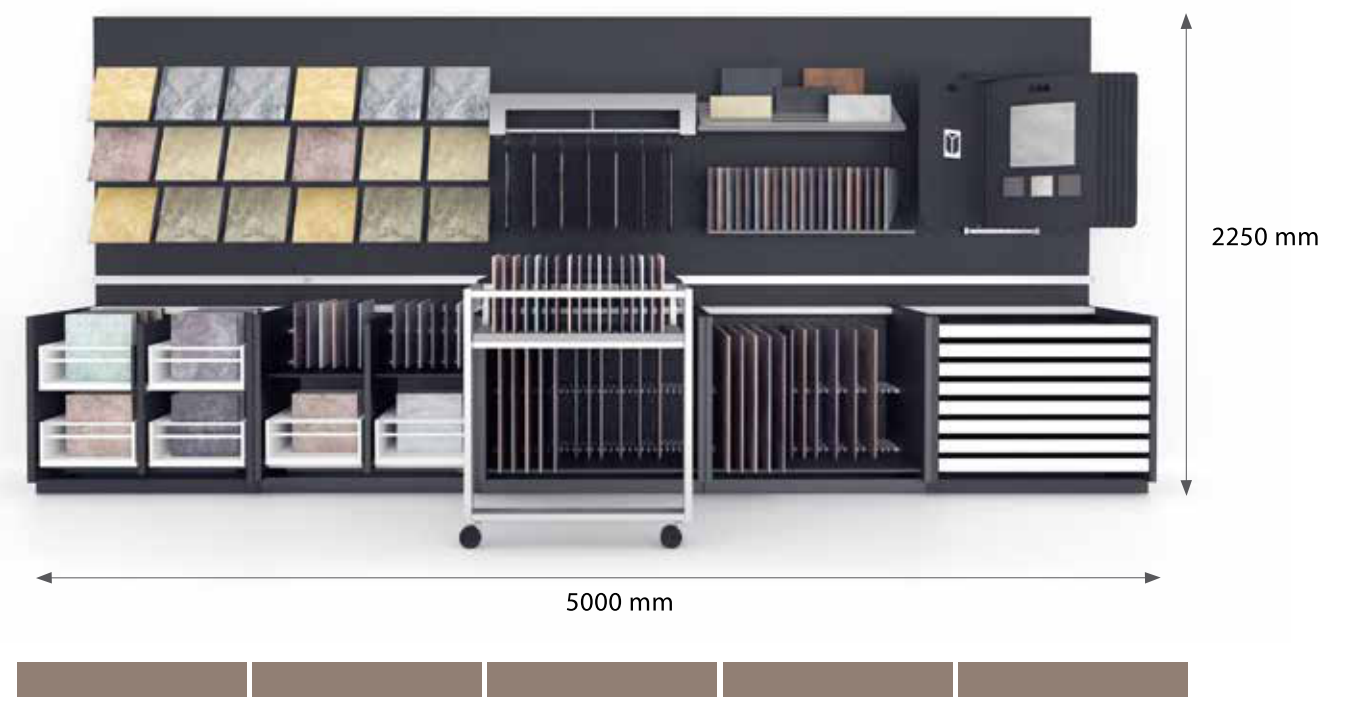

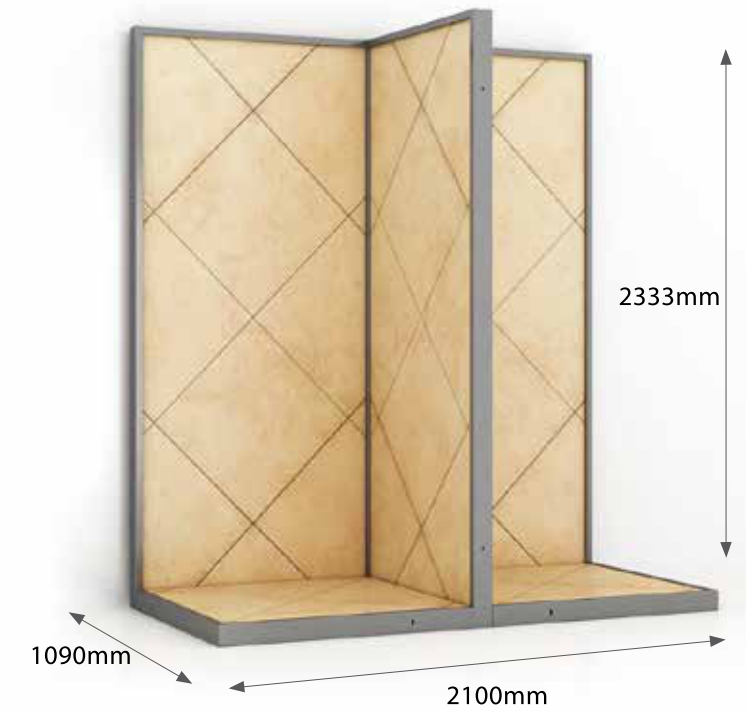
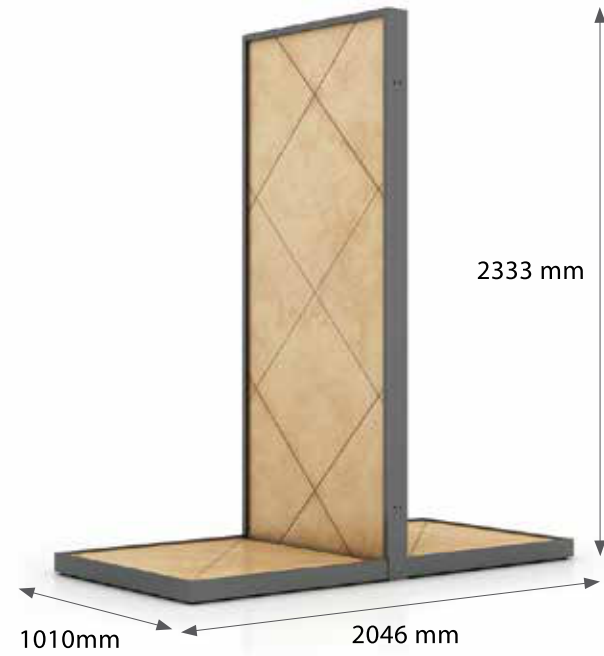

European standard technology,
scientific bypass structure

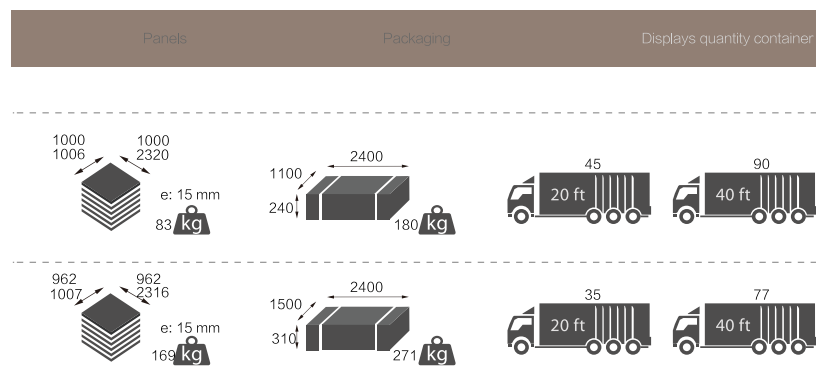
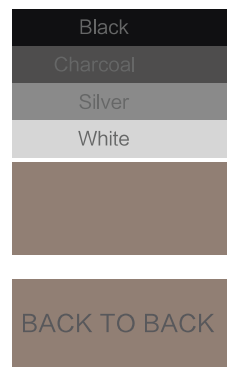

European standard technology,
scientific bypass structure

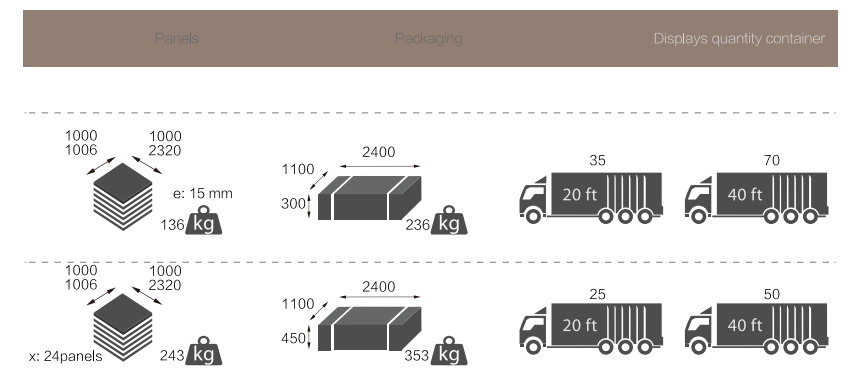
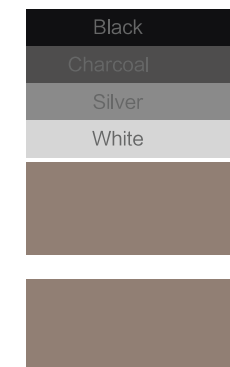

Ceramic display rack global customization



TRIM

Parallel push-pull design, not only can all-round display of the whole, but also can do partition of the wall area, and can even do the screen display.

European standard technology, scientific bypass structure



	<p>Panels</p>
	<p>Packaging</p>
	<p>Displays quantity container</p>

Ceramic display rack global customization



European standard technology,
scientific bypass structure



	Panels		
	Packaging		
	Displays quantity container		

European standard technology,
scientific bypass structure



	Panels		
	Packaging		
	Displays quantity container		

Ceramic display rack global customization

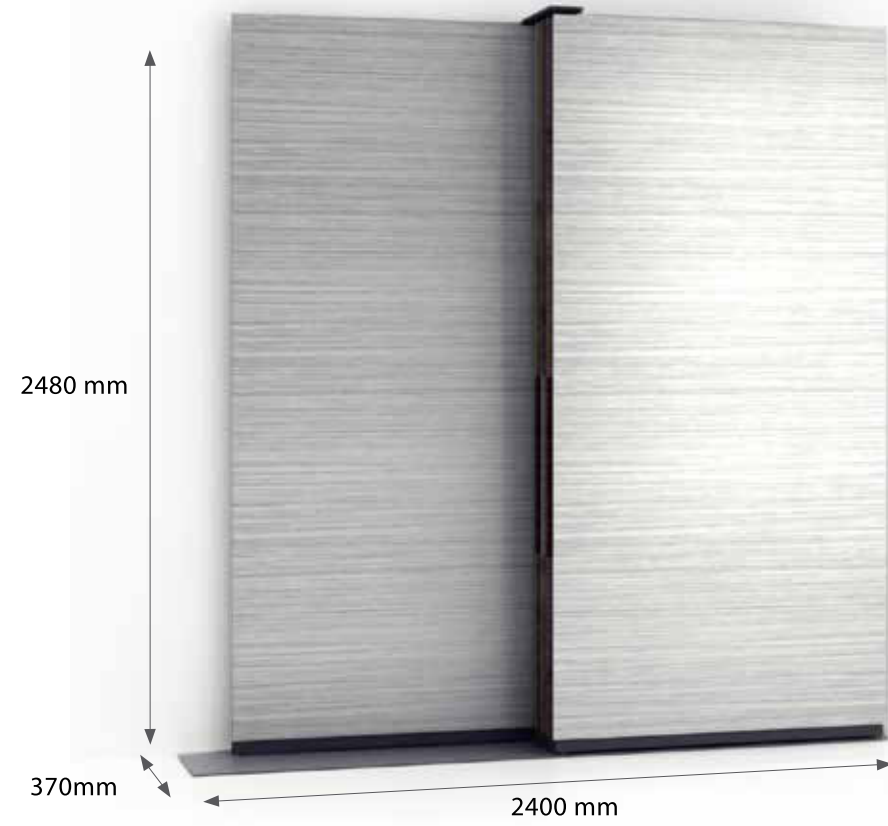

European standard technology,
scientific bypass structure

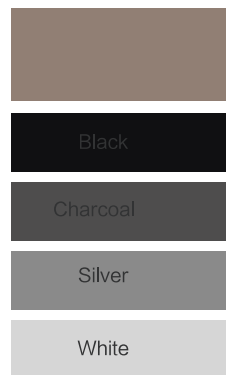

Panels	600 x 1200 e: 5 mm x: 17panels	150 kg
Packaging	610 x 2630 x 300	120 kg
Displays quantity container	20 ft / 40 ft	

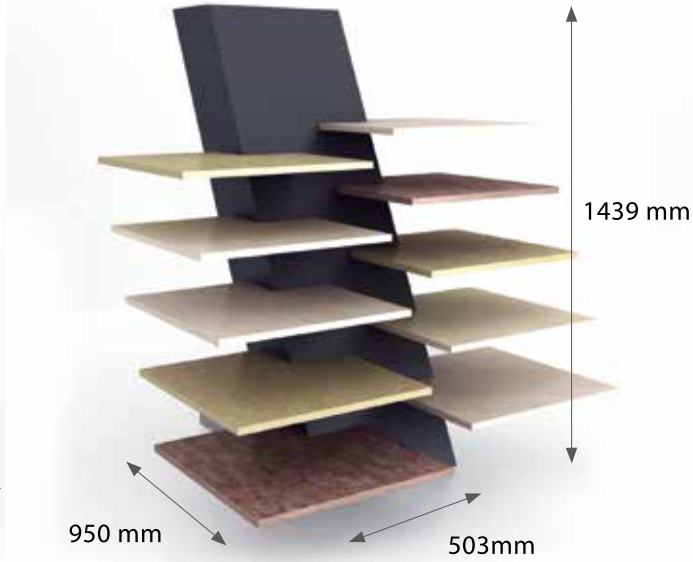
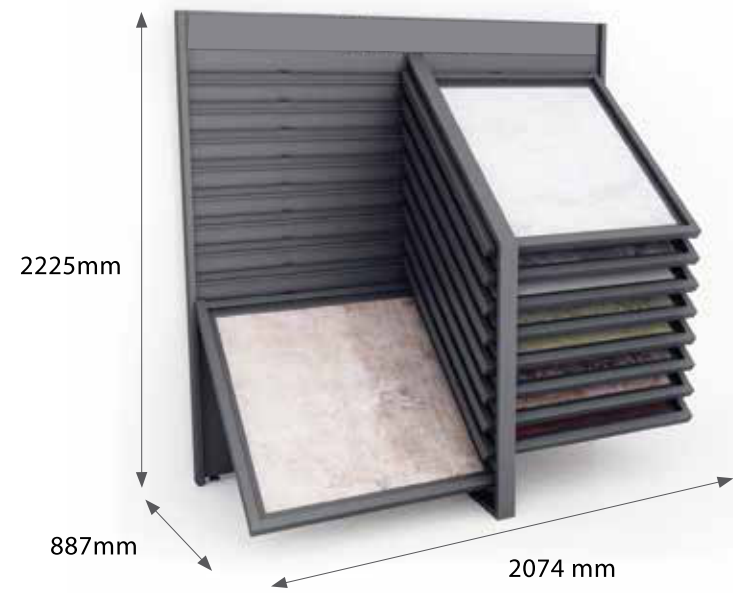

600X600,
800X800,
1000X1000,
1200X1200,
1600X1800

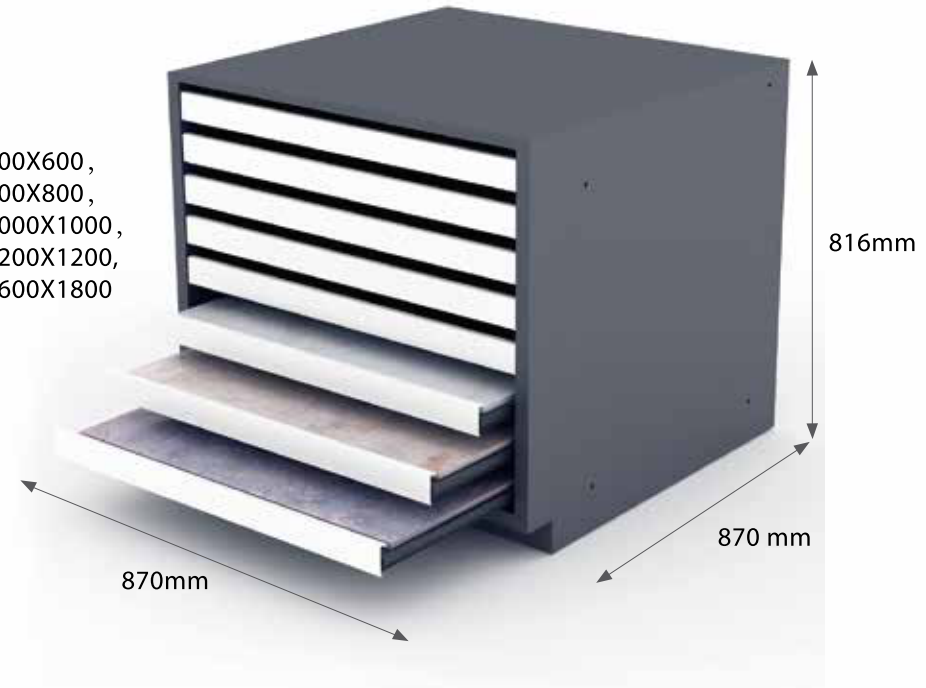

There are various specifications to choose from.

Fixed installation by wall, no floor required.

Fixed installation by wall

European standard technology,
scientific bypass structure

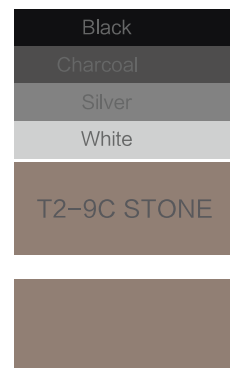

	Panels	Packaging	Displays quantity container
T2-9C STONE	1200x1000, e: 15mm, x: 9 panels, 45 kg	1180x2270, 770mm height, 483 kg	4x 20 ft, 8x 40 ft
	600x600, e: 20mm, x: 10 panels, 15 kg	1150x1900, 520mm height, 544 kg	4x 20 ft, 8x 40 ft

European standard technology,
scientific bypass structure

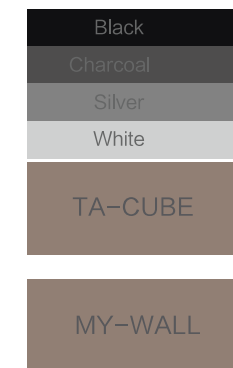

	Panels	Packaging	Displays quantity container
TA-CUBE	800x800, 80 kg	930x950, 60 kg	4x 20 ft, 8x 40 ft
MY-WALL	Various sizes can be customized.		4x 20 ft, 8x 40 ft

Ceramic display rack global customization

Original patent product

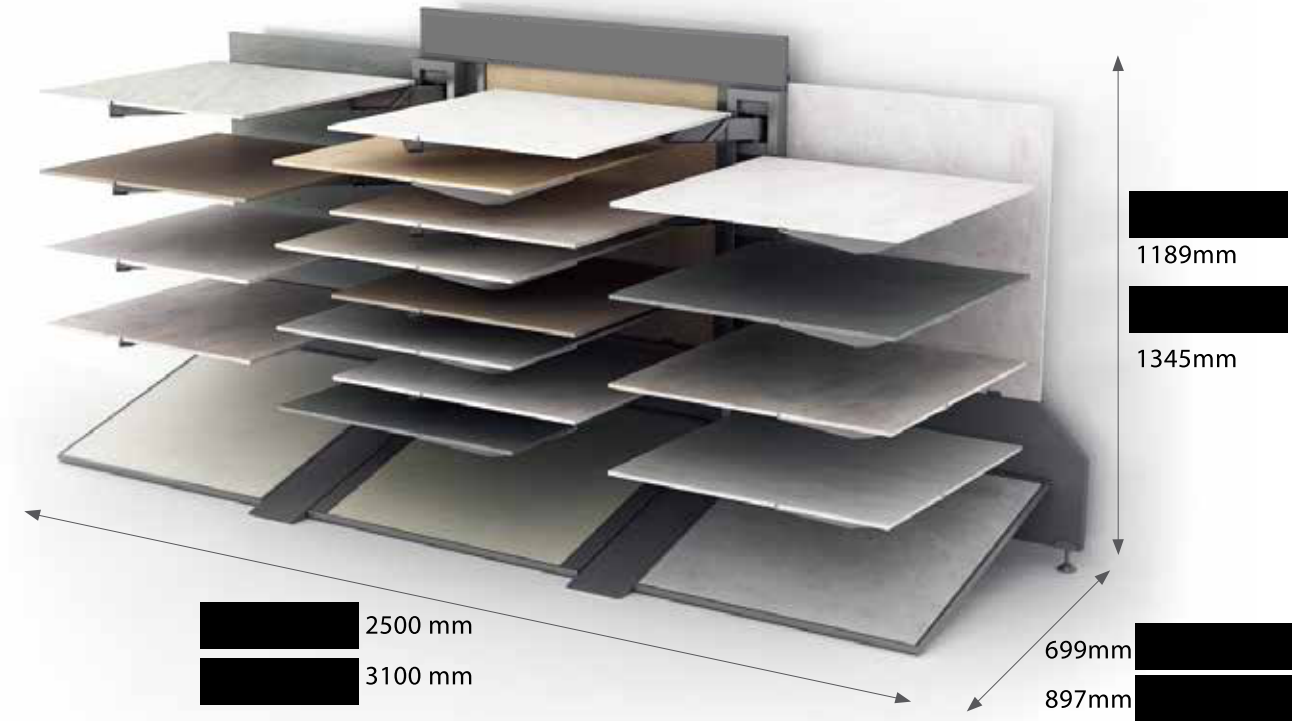
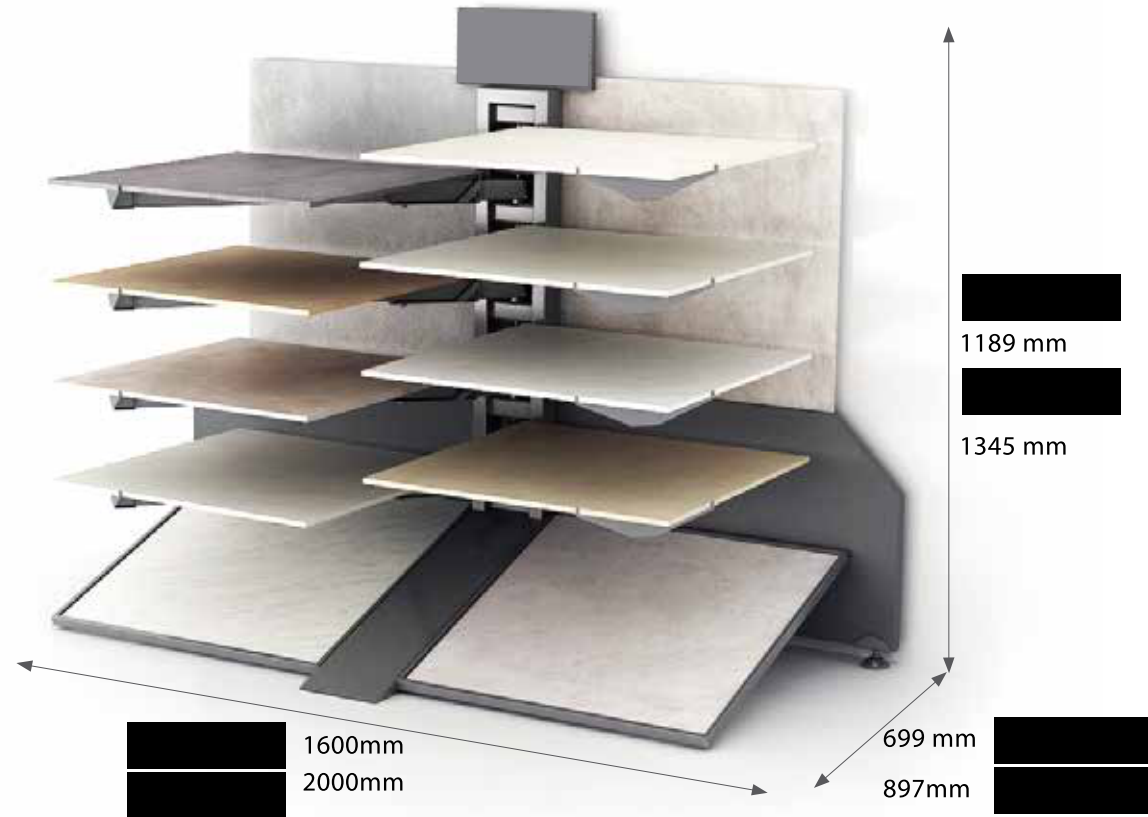

Fixed installation by wall

European standard technology,
scientific bypass structure



G3 12C(600/800)	Panels	600 e: 12 mm 600 x:12 panels	9kg
Black	Packaging	700 380 1080	102.5 kg
Charcoal	Displays quantity container	76 20 ft	160 40 ft
Silver			
White			

European standard technology,
scientific bypass structure



G3 22C 600/800	Panels	600 e: 12 mm 600 x:12 panels	9kg
Black	Packaging	700 570 1080	142kg
Charcoal	Displays quantity container	1 20 ft	3 40 ft
Silver			
White			

Ceramic display rack global customization



European standard technology,
scientific bypass structure



W3	Panels	100	100	Weight icon
Black	Packaging	780	2400	372 kg
Charcoal	Displays quantity container	8	20 ft	18
Silver				
White				

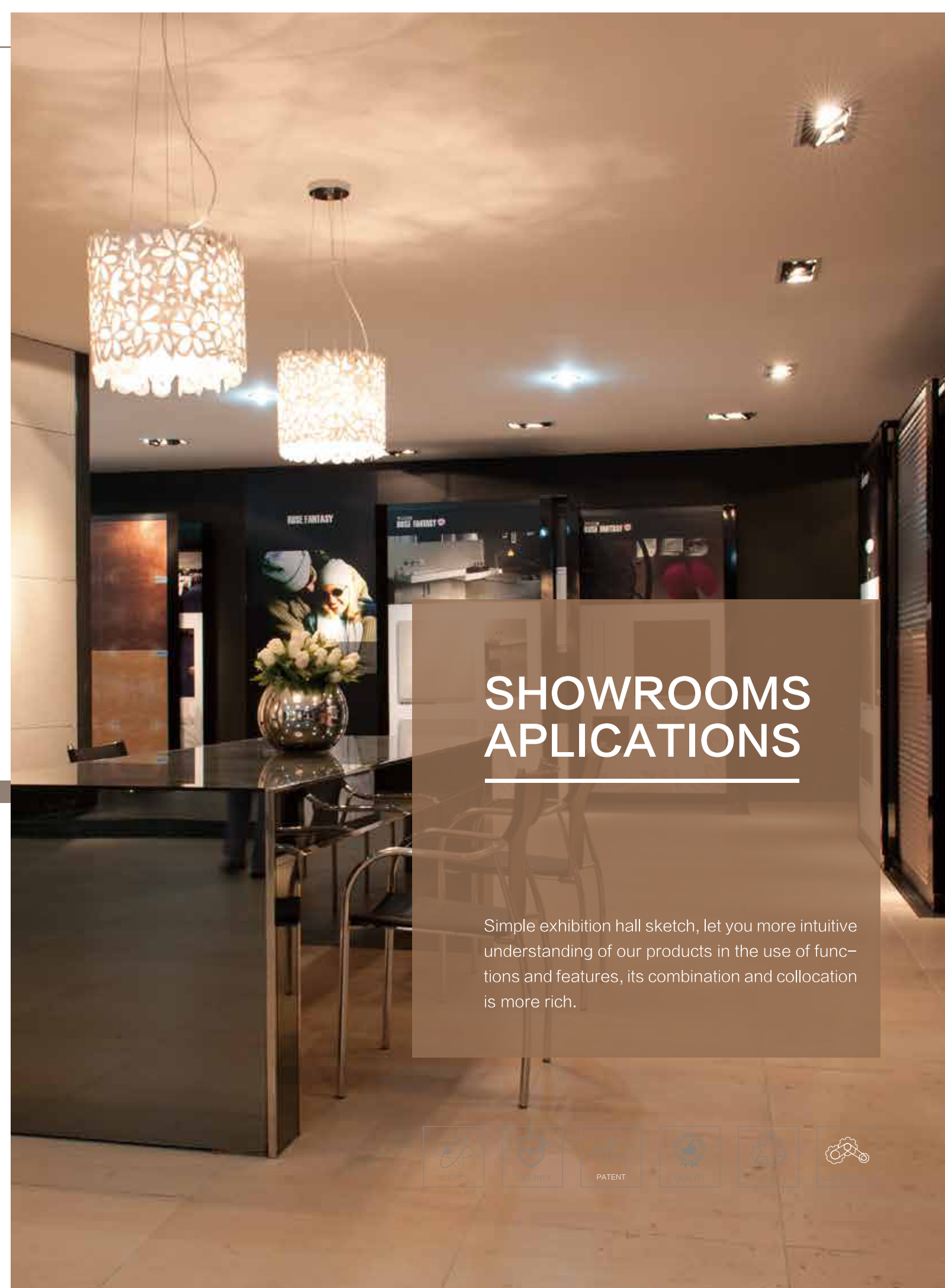

SHOWROOMS APPLICATIONS

Simple exhibition hall sketch, let you more intuitive understanding of our products in the use of functions and features, its combination and collocation is more rich.

